

OTH-7000

REMOTE OPTICAL TEST HEAD

Scalable test solution for fiber optic network construction, monitoring and management.

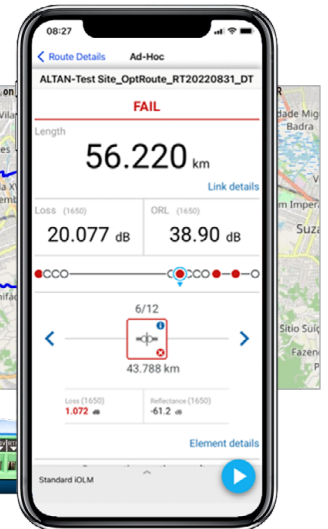
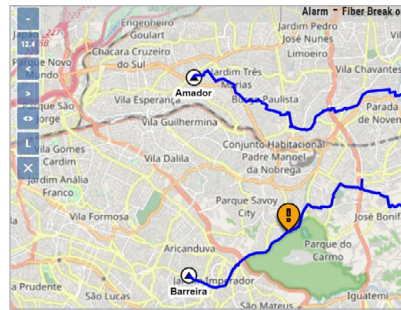

KEY FEATURES

- Smallest footprint in the industry (up to 64 ports in 1/2 RU) with front-only connectivity
- Scalable to hundreds of ports through external switches (local or distributed)
- Optical transceiver module SFP port
- Dark and in-service fiber monitoring
- P2P fault on map (optional GIS)
- Dual power feeds with low power consumption
- On-demand tests available anytime, anywhere through mobile app for on-site repair confirmations
- Configurable as client API hardware for direct integration to network management system (NMS) or controlled over EXFO FMS

APPLICATIONS

- End-to-end continuity and loss verification for centralized PON certification
- PON monitoring
- Fiber monitoring for dark-fiber providers, data centers, utilities and service providers
- Point-to-point (P2P) link certification with pass/fail thresholds and iconic viewer (with iOLM technology)
- Fault analysis and troubleshooting
- Advanced analytics
- Integration with third-party solutions
- Local WebUI tests without centralized server

RELATED PRODUCTS

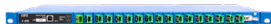

External MEMS optical switch
RTUe-9120
OTAU-9150



OTDR/traffic WDM coupler
Test Access Module Kit (TAMK) and high density FWDM cassettes



INTEGRATED OTDR AND OPTICAL SWITCH

Part of EXFO's solution for remote fiber testing and monitoring (RFTM), the OTH-7000 is the smallest footprint (½ U rackmount space) optical test head with an embedded OTDR and optical switch.

OTH-7000 is remotely controlled via EXFO's central fiber monitoring system (FMS) for fiber certification and monitoring through patented OTDR/iOLM technology or can be directly integrated to your systems as a client API OTDR.

In-service testing and monitoring of P2P and PONs is possible thanks to a filtered OTDR port at 1650 nm coupled with a compact test access module coupler (up to 64 ports per ½ U rackmount space). PON end-to-end fiber attenuation at 1650 nm is measured with a traceable test method using a high-reflectance demarcation filter.

OTH-7000 is available with a choice of 1, 4, 16, 32, 48 or 64 ports. Optical link management can be scaled up to hundreds of ports with compact external optical switches (local or remote, up to 256 ports per ½ U rackmount space). With its MEMS-based design optical switch, the OTH-7000 delivers durable performance in a compact package. Fast switching time and a 1-billion cycle lifetime expectancy make it ideal for the demanding needs of production testing, monitoring applications or PON certification.

OTH-7000 family is expanding with the UBRD model designed for PON applications. Thanks to its narrower laser and filtering, the UBRD model is also optimal on P2P live networks when the upper L Band is used by traffic or supervisory.

FIBER NETWORK TYPES	OTH-7000-AWAT	OTH-7000-UBRD
P2P dark fiber	●	○
P2P live fiber	●	○
P2P live fiber with L band traffic or supervisory		●
PON dark & live		●

● Optimal ○ Suitable

KEY OTDR-iOLM CAPABILITIES FOR P2P MONITORING

Ideal for point-to-point link testing and monitoring, the OTH-7000 uses EXFO's renowned iOLM mode, which allows users to monitor and characterize P2P networks, and provides a centralized management view and functions. Automated, expert-level fiber testing eliminates the need to manually configure parameters or analyze and interpret multiple complex OTDR traces.

The iOLM algorithm discovers elements on the fiber and are tested against pass/fail criteria, with loss/reflectance and distance values included in the same structured data.

Providing single-test baselining and on-demand testing for fault analysis, iOLM mode allows the user to see deviation(s) and an iconic view, as well as the ability to view and extract each individual pulse OTDR trace as part of the iOLM measurement. The user can also specify a golden trace among the test sequence, for expert-level testing and diagnosis.



HOW DOES IT WORK?

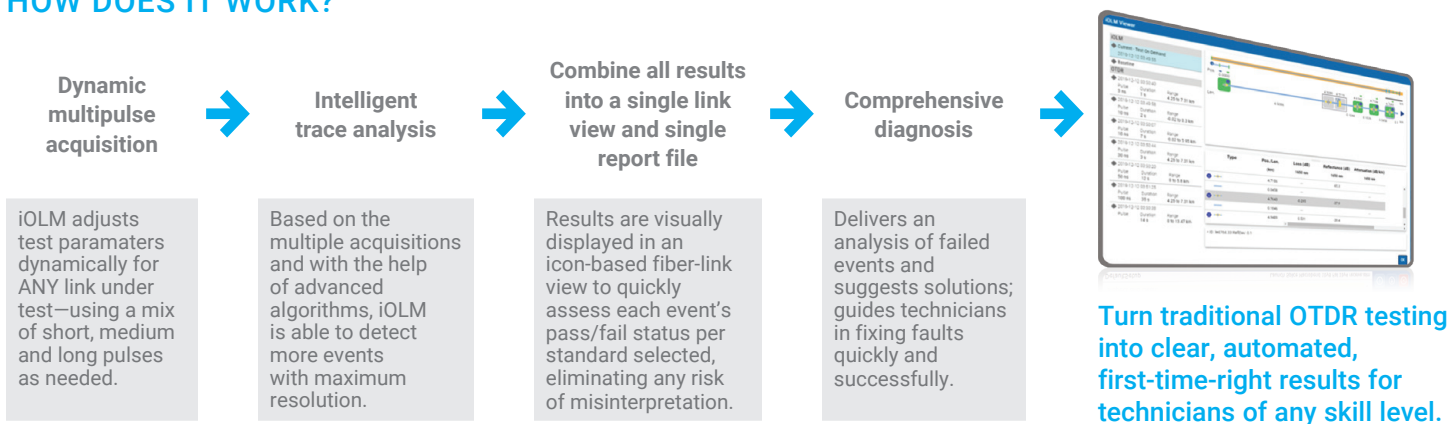

KEY OTDR-iOLM CAPABILITIES FOR PON

End-to-end loss measurement

A practical function of the iOLM is its ability to measure end-to-end loss or optical attenuation between the OTDR's location (the central office or a cabinet hosting the OLT) and any connector port downstream—even when a port is beyond a series of splitters. By simply splicing or inserting a high-reflectance demarcation (HRD) filter and using a mobile smart app, link characterization can be done within 15 seconds.

Key information and values:

- Confirmation of proper upstream connectivity
- Loss and expected loss budget (dB) at the measured point of the network
- Optical fiber length-correlation with network documentation
- Test point geolocation confirming terminal availability to serve a specific location

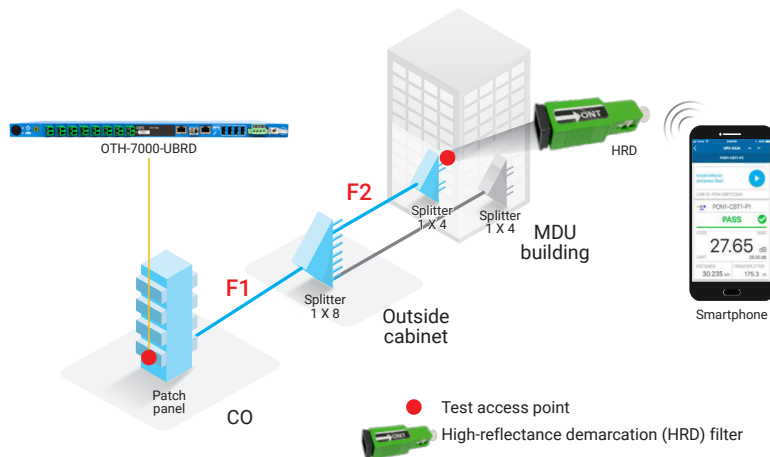

Link certification in a PON architecture with end-to-end connectivity.

Attenuation is measured from the node to any connection terminal using the OTH-7000 OTDR and an HRD filter. This is performed by a field technician who is testing on one or every port of a second-stage splitter during network installation or when certifying a contractor's work.

OPTICAL SWITCHES: SCALING REMOTE TESTING CAPABILITIES

Expansion unit – external 1×N optical switch (RTUe-9120)

Connect the single port OTH-7000 unit directly to the common port of the RTUe-9120 external optical switch unit. The RTUe-9120 is a highly dense switch allowing up to 256 ports (MPO 16f connectors).



Local or remote expansion unit: 1×N optical switch OTAU-9150 with optional built-in live coupler

Broaden the reach of the OTH-7000 by using the compact (½ U rack height) OTAU-9150 switch, either locally or in any remote locations within the network: core, metro and access networks. For a cost-effective solution, leverage a single OTDR test head to supervise multiple links located at various edge sites.

Less fiber utilization to reach end point

The OTAU-9150 is available with up to 1×144 port count. This switch achieves outmost port density and low insertion loss to meet tight optical loss budgets.

SCALABLE SYSTEM WITH GREAT FLEXIBILITY

- OTH-7000 platform is managed by EXFO’s FMS, a scalable system that can control and manage up to 1000 units with horizontal scaling capabilities.
- OTH-7000 platform is a true client requiring a minimal outbound firewall to be opened for messaging-based communication using https-encrypted protocol.
- Integration by third parties can be done through micro-services APIs offering the exact functional capability the FMS web and mobile clients (UIs).
- EXFO FMS analytics includes customizable dashboards and customizable APIs. Key fiber metrics such as length, end-to-end loss, dB/km, are trackable in time and/or by domain – allowing pro-active maintenance of the network.
- GIS Integration through standard APIs can be performed to connect to a third-party GIS.

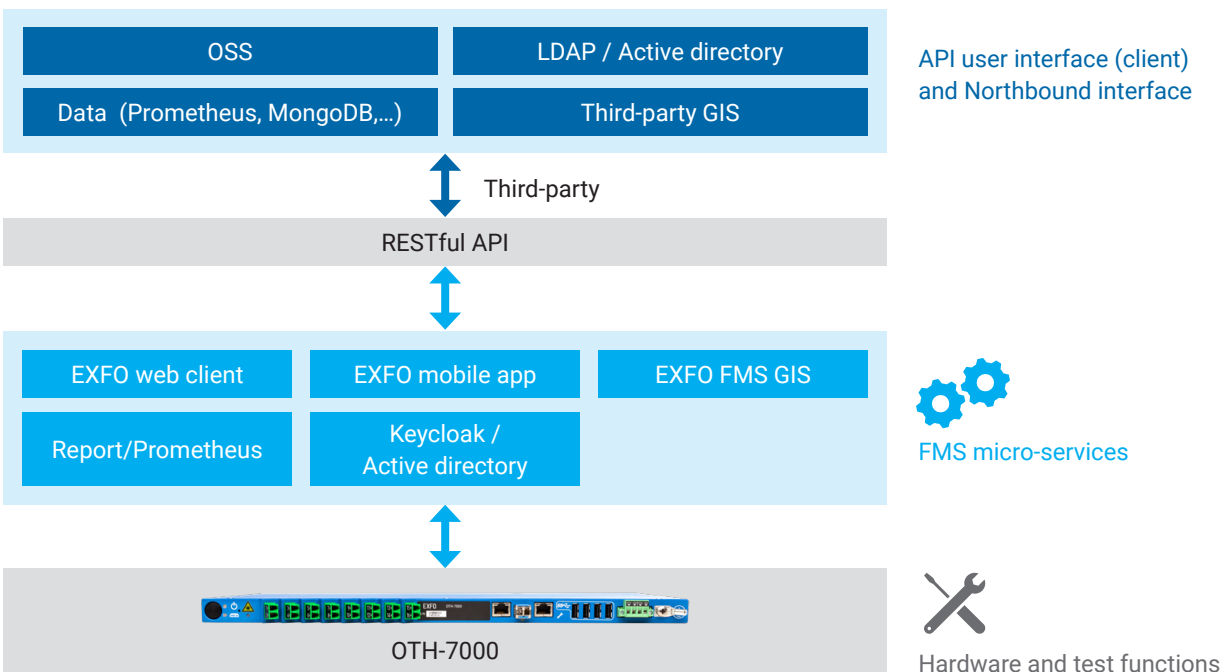

WEBUI WITH LOCAL OTDR TESTS AND SUPPORTED APIs FOR 3RD PARTY INTEGRATION

Instead of being controlled by EXFO FMS, the OTH-7000 can be configured to be controlled directly through its WEBUI or by your network management system (NMS) via open REST APIs on the unit ^a.

The Web Interface of the OTH-7000 also allows the local creation of local routes and execution of different tests (Baseline, Test-On-Demand and AdHoc) which can be visualized in standard OTDR and in EXFO's proprietary iOLM format. Historical status of the tests and related measurements are kept locally on the OTH-7000.

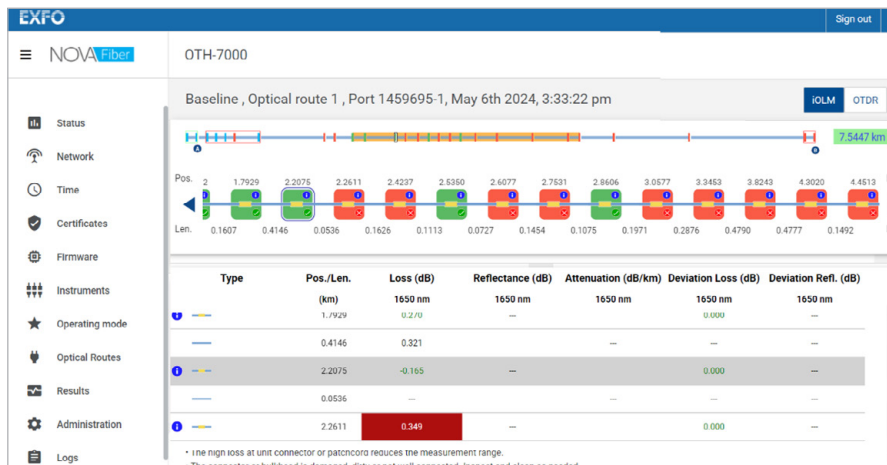

Integrate the OTH-7000 client API to your corporate system to store OTDR measurements, perform analysis operations (such as fiber loss calculations) or create configuration files and templates for fiber breaks and degradations. The OTH-7000 client API removes fiber monitoring EMS requirements and bundles remote equipment control/management into fewer software instances within the corporate network.

Execute tests to detect and precisely locate any deviation from the initial condition with standard OTDR technology (Bellcore .sor). Testing can be programmed or launched on demand from your OSS or SDN controller to get OTDR measurements and perform further analysis. The OTH-7000 will return the fault status (dB loss and distance) from a simple API call.

Based on a known IP or machine name, you can easily query optical test inventory. For instance, if your NMS or OSS detects a device outage, you can integrate the OTH-7000 client API to determine if the root cause is related to the fiber, hence reducing mean time to understand (MTTU) when a lack of network communication occurs. This helps to create workflows between transport and test equipment.

The OTH-7000 as a client can be integrated into your development software through web API calls to test optical routes. This function is crucial for data centers, utility groups, TELCOs, network operators and so on. Reduce OPEX/CAPEX with less cost and maintenance fees by using an integrated open API solution for your GIS, NMS, OSS or SDN controller.

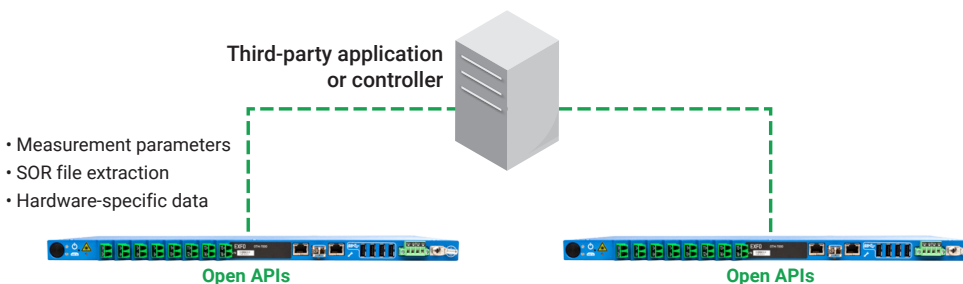

a. Feature set from EXFO FMS is not available in Client API mode

PLATFORM SPECIFICATIONS

- 1 Power button
- 2 Power LED
- 3 Laser warning icon
- 4 System status LED
- 5 Laser status LED
- 6 Optical ports (1, 4, 16, 32, 48 or 64)
- 7 Ethernet ports
- 8 SFP port (SFP not included)
- 9 USB 2.0 (4)
- 10 -48VDC dual feed input
- 11 Ground lug
- 12 Removable rackmount brackets

½ U configuration (1, 4, 16, 32, 64 ports)



1 U configuration (48 ports)



SPECIFICATIONS

All specifications valid at 23°C ± 2°C unless otherwise specified - OTDR specifications at internal connector output.

INTERNAL OTDR	AWAT	UBRD
Laser type	Fabry-Perot	DFB
Central wavelength (nm) ^a	1650 ± 15	1650 ± 5
Dynamic range (dB) ^{a,b}	42	41
Acquisition mode	OTDR through API or iOLM through FMS	
Internally filtered (live fiber ready)	Yes	
Internal filter width (nm)	High pass at 1620 nm	Bandpass 1650 nm ± 7 nm
Event dead zone (m) ^{a,c}	0.9	
Attenuation dead zone (m) ^{a,c}	3.5	
Sampling points	Up to 132 000 per OTDR acquisition, multiple acquisitions per measurement in iOLM mode	
HRD measurement loss range (dB)	n/a	13 to 35
HRD minimum distance separation (m) ^d	n/a	2
Sampling resolution (m)	0.04 to 10	
Pulse width (ns)	3 to 20 000	
Distance range (km)	Up to 320	
ORL uncertainty (dB) ^a	± 2	
Reflectance uncertainty (dB) ^{a,e}	± 2	
Linearity (dB/dB) ^a	0.05	
Distance uncertainty (m) ^f	±(0.75 + 0.0025 % × distance + sampling resolution)	
Source mode tone frequencies (Hz)	270, 330, 1000, 2000	

INTERNAL OPTICAL SWITCH	AWAT	UBRD
Number of optical ports	1-port SC/APC or 4-port SC/APC or 16-port duplex LC/APC 48-port duplex LC/APC	1-port SC/APC or 4-port SC/APC or 32-port MPO-APC (16 fibers populated onto a standard MPO-24 fiber ferrule) or 64-port MPO-APC (16 fibers populated onto a standard MPO-24 fiber ferrule)
Internal optical switch type	MEMS	
Internal optical switch lifetime (minimum number of cycles)	2.5 billion (10 ⁹) ^g	1 billion (10 ⁹)
Insertion loss (dB) ^{a,h}	4-port SC/APC 16 or 48 ports duplex LC/APC 32 or 64 ports MPO/APC	1 2.5
Back reflection (dB) ⁱ	≤ -50	

a. Typical

b. Typical dynamic range with longest pulse and three-minute averaging at SNR = 1. Excluding optical switching loss.

c. For reflectance below -55 dB, using the smallest pulse width available, with 45 s averaging.

d. Typical, for similar level of attenuation between both.

e. For 3 ns to 1 000 ns pulses, 45 s averaging, -45 dB reflectance, not including RBS uncertainty.

f. Does not include uncertainty due to fiber index or cable characteristics (e.g., helix factor).

g. For the 4-port model, lifetime is 1 billion (10⁹).







h. Including connectors.

i. For the 48 port model the back reflection is ≤ -45 dB.

GENERAL SPECIFICATIONS	
Operating system	Linux
USB interfaces	USB 2.0 (4)
Wired network interfaces	2x 10/100/1000 Base-T Ethernet IP-V4 and V6 (network and management interfaces) 1x SFP (network interface)
Unit status front LEDs	Power, system and laser status
Storage	16 GB
Dual feed power supply	-48VDC 2A (ordering option: external AC-DC adapter for AC operation)
Power consumption	10 W (typical) Over entire operating temperature range
Dimensions (for 19 in or ETSI racks) (H × W × D)	All configurations except AWAT-48: 22 mm (1/2 U) × 440 mm × 220 mm (7/8 in × 17 5/16 in × 8 11/16 in) Compatible with ETSI 300 mm deep racks Configuration AWAT-48: 44 mm (1 U) × 440 mm × 220 mm (1 3/4 in × 17 5/16 in × 8 11/16 in)
Weight (includes brackets)	All configurations except AWAT-48: 1.4 kg (3.1 lb) Configuration AWAT-48: 1.75 kg (3.8 lb)
Temperature	Operating ^a Storage
	0 °C to 55 °C (32 °F to 131 °F) -40 °C to 70 °C (-40 °F to 158 °F)
Relative humidity	< 95 % non-condensing
Heat management	No fan

SOFTWARE OPTIONS AND OPTIONAL ACCESSORIES	
SFP-85919	SFP copper, multirate optical transceiver module 10/100/1000 BASE-T
FTB-8591	SFP multirate optical transceiver module LC, SMF, 10 km reach
FTB-8196	SFP multirate optical transceiver module, rates: 155/622 Mbit/s, 1550 nm, LC, SMF, 80 km reach
GP-3170	1U 19 in to ETSI extender (for 1U configuration)

STANDARD RTU ACCESSORIES
User guide
Rackmount kit

REGULATORY	
Certification marks	     <small>CSA C22.2 No. 61010-1 UL 61010-1</small>
EMC/EMI	EN 61326-1 (Immunity Industrial level), EN 55011, CISPR 11, FCC 47 CFR Part 15, Subpart B, ICES-001, ETSI/EN 300 386
Electrical safety	IEC/EN 61010-1, USA/UL 61010-1, CAN/CSA-C22.2 61010-1-12
Optical safety	IEC 60825-1, 
Nebs	GR-63-CORE, GR-1089-CORE ^b
ETSI	ETSI/EN 300 019-2-1, ETSI/EN 300 019-2-2, ETSI/EN 300 019-2-3, ETSI/EN 300 386, ETSI/EN 300 753, ETSI/EN 300-132-2

a. For DC operation. Maximum 45°C when stacked with other equipment on top or underneath.

b. The equipment is NEBS-compliant based on Verizon VZ.TPR.9305 for test and measurement equipment-permanent installation for DC-powered, permanent installation type 2 equipment, and AT&T ATT-TP-76200 (Carrier Grade level 1). Contact factory or visit the following URL for more details about this certification: www.verizonnebs.com/TPRs/VZ-TPR-9305.pdf.

ORDERING INFORMATION

OTH-7000-XX-XX-XX-XX

Wavelength

AWAT = Filtered Fabry-Perot 1650 nm
 UBRD = Filtered DFB 1650 nm

Port option

01 = 1 port
 04 = 4 ports
 16 = 16 ports^a
 32 = 32 ports^b
 48 = 48 ports^a
 64 = 64 ports^b

Power

AC = External 100-240 VAC converter with power cord
 DC = Internal DC 48V power supply

Rackmount option

RK19-HALFU = ½ U rackmount kit (19 inch)^c
 RKET-HALFU = ½ U rackmount kit (ETSI)^c

Example: OTH-7000-AWAT-16-DC-RK19-HALFU

a. Available for AWAT model only.

b. Available for UBRD model only.

c. Available for all port option configurations except 48 ports. The 48-port configuration comes with 1 RU 19-in brackets. ETSI bracket extenders can be ordered separately (GP-3170).

EXFO headquarters T +1 418 683-0211 **Toll-free** +1 800 663-3936 (USA and Canada)

EXFO serves over 2000 customers in more than 100 countries. To find your local office contact details, please go to www.EXFO.com/contact.

For the most recent patent marking information, please visit www.EXFO.com/patent. EXFO is certified ISO 9001 and attests to the quality of these products. EXFO has made every effort to ensure that the information contained in this specification sheet is accurate. However, we accept no responsibility for any errors or omissions, and we reserve the right to modify design, characteristics and products at any time without obligation. Units of measurement in this document conform to SI standards and practices. In addition, all of EXFO's manufactured products are compliant with the European Union's WEEE directive. For more information, please visit www.EXFO.com/recycle. **Contact EXFO for prices and availability or to obtain the phone number of your local EXFO distributor.**

For the most recent version of this spec sheet, please go to www.EXFO.com/specs.

In case of discrepancy, the web version takes precedence over any printed literature.