

PSO-200

OPTICAL MODULATION ANALYZER

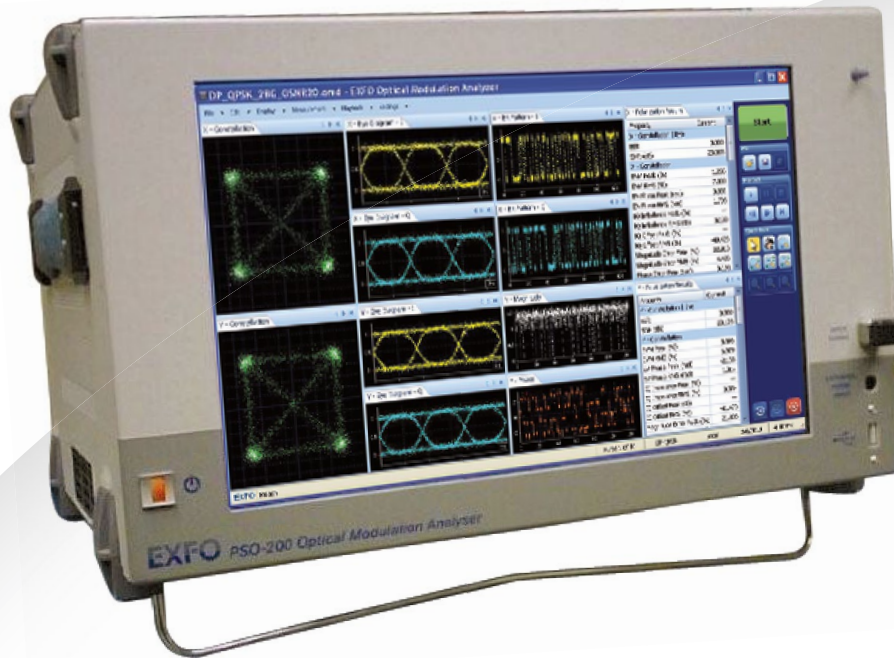

Future-proof characterization of any optical signal

KEY FEATURES

All-optical design providing the effective bandwidth to properly characterize waveforms and signals at 40 Gbit/s, 100 Gbit/s, 400 Gbit/s, 1 Tb and beyond

Compatible with dual-polarization transmission

Fully integrated with the smallest form factor in the industry

Includes all the required tools for testing of transmitters in manufacturing such as EVM, BER and masks

Large touchscreen for high graphic quality and easy instrument control

ALL-OPTICAL SAMPLING—NO BOUNDARIES

With the new advanced modulation schemes that enable transmission of high-speed optical signals over fiber, research centers, network equipment manufacturers (NEMs)—and eventually carriers—need new test instruments to properly characterize these signals.

Like EXFO's recognized PSO-100 Series Optical Sampling Oscilloscopes, the PSO-200 Optical Modulation Analyzer uses optical sampling, allowing complete characterization of random or repetitive digital signals up to 100 GBd.

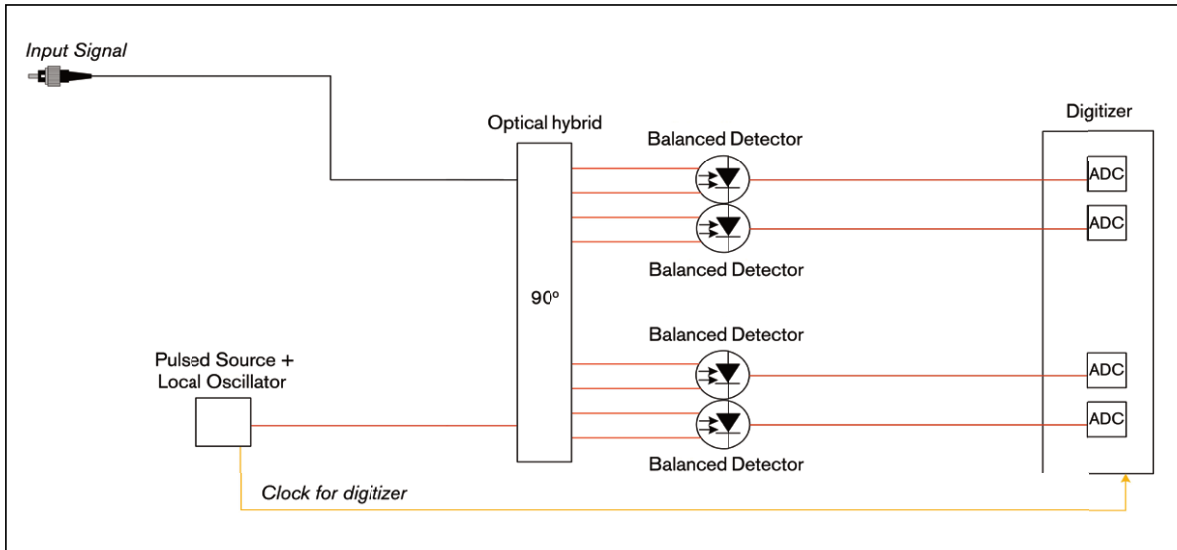

Distortion-Free Signal Recovery

One of the crucial elements to take into account when characterizing or optimizing transmitters and modulators is the recovery of perfect signals and waveforms. A distortion-free signal recovery is precisely what the optical sampling technique used in the PSO-200 brings when compared to electrical sampling. With the PSO-200, there are no bandwidth limitations—no impedance mismatch.

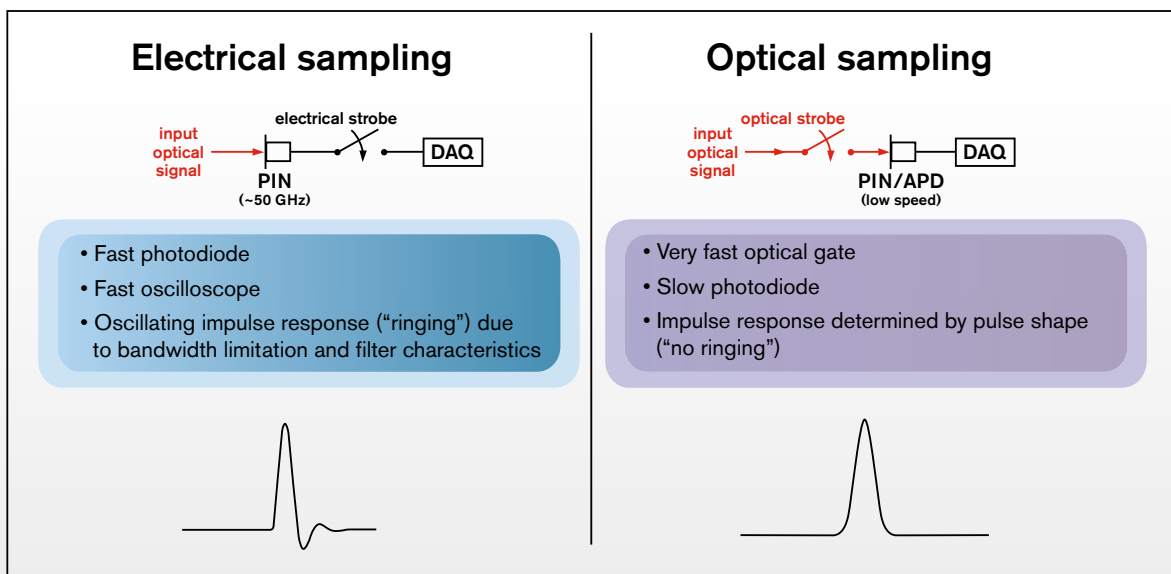

Electrical vs. optical sampling techniques.

With high bandwidth and low distortions the PSO-200 is able to measure constellation diagrams with very high fidelity without the need for equalization or DSP enhancement.

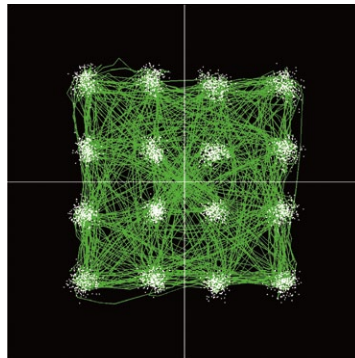

28 GBd 16-QAM

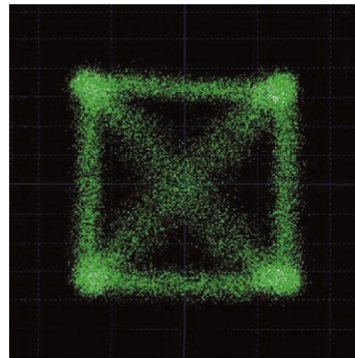

66 GBd NRZ-QPSK

Any Transmission Rate, Any Modulation Format

The PSO-200's flexible design makes it a future-proof tool to characterize—without distortion—any optical signal. Its effective bandwidth is broad enough to support constellation and eye-diagram analysis of signals at rates beyond 1 Tbit/s.

Thanks to detailed and accurate amplitude and phase patterns, the PSO-200 then performs in-depth pulse shape analysis for transmitter testing both in R.-D. and manufacturing environments.

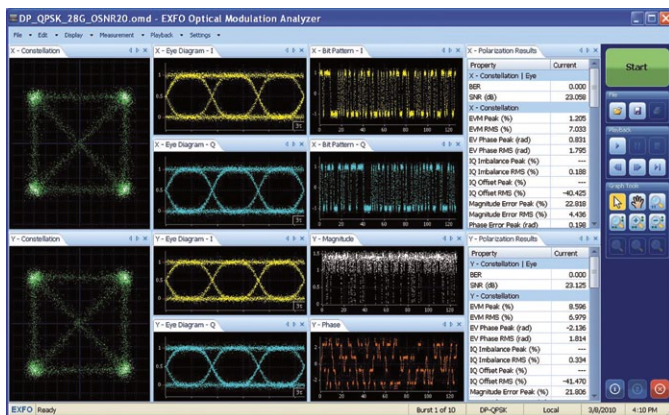

28 GBd DP-QPSK

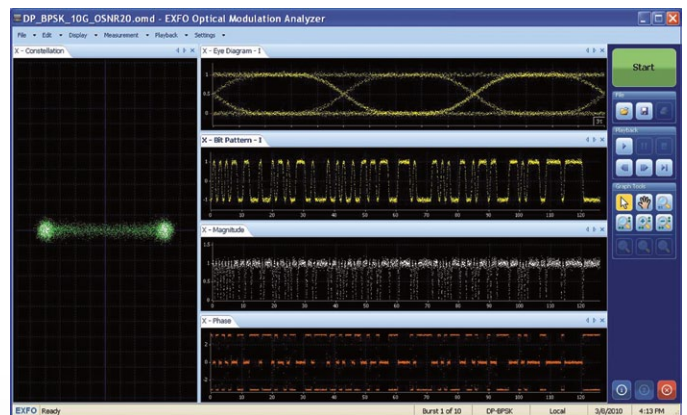

10 GBd BPSK

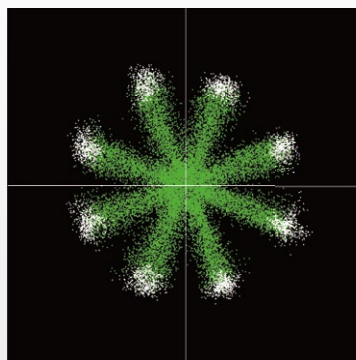

40 GBd RZ-8-PSK

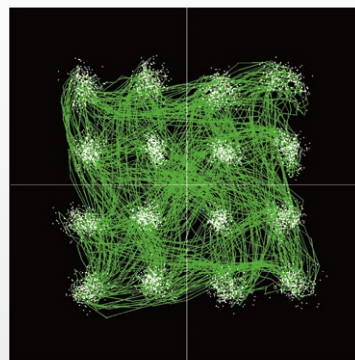

28 GBd 16-QAM after 1.8 km of singlemode fiber

UNIQUE ANALYSIS FOR TRANSMITTER TESTING AND TROUBLESHOOTING

Advanced modulation formats in which the information is encoded—not only in the intensity but also in the phase of the signal—require a much more detailed and complex analysis of the signals and waveforms that include new measurements such as the error vector magnitude, polarization unbalance, quadrature error, etc. The PSO-200 offers the full flexibility for users to select the best views and measurements required to meet their needs.

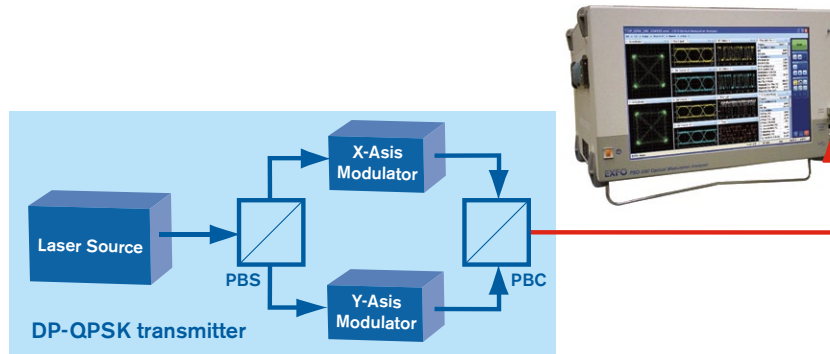

Constellation, Eye Diagrams and Patterns

Important information about the quality of the signal transmitted can be recovered from the constellation diagram. The PSO-200 offers powerful analysis capabilities to identify issues such as quadrature errors, imbalance between the I and Q branches of the modulators, signal-to-noise ratio (SNR) issues, etc. The large bandwidth of the PSO-200 allows precise recovery of constellation diagrams, including the transition information. Each polarization can also be analyzed as two I and Q eye diagrams or using time-domain patterns (e.g., as in the case of QPSK or DQPSK). What's more, these diagrams provide additional information about the signal quality, such as information on skew, jitter and other timing issues.

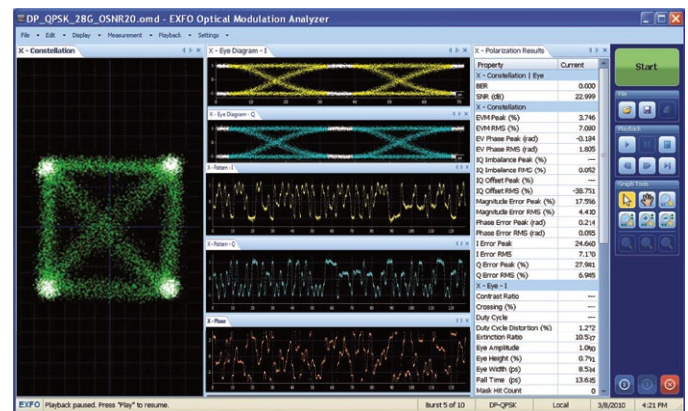

X polarization, 28 GbD DP-QPSK

Error Vector Magnitude

The quality of the transmitted signal can also be established by looking at the error vector magnitude, which compares the recovered signal to an ideal signal. The PSO-200 not only provides the value of the EVM but also its evolution over time.

The unique time-resolved error vector magnitude (EVM) analysis, developed by EXFO, allows user to quickly identify Tx impairments and apply masks for fast and precise pass/fail decision in manufacturing.

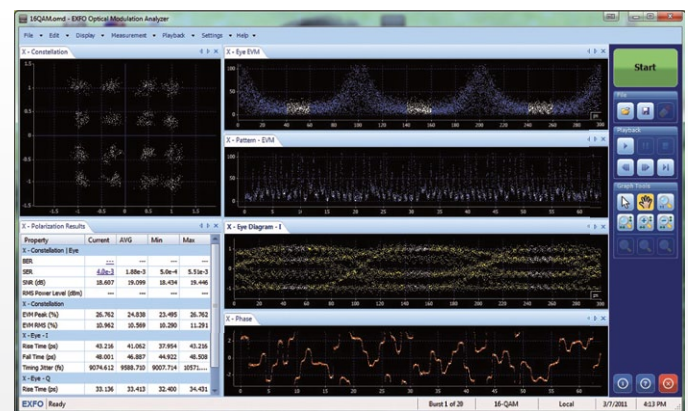

Pattern recovery, 28 GbD DP-QPSK

Bit Error-Rate Analysis (optional)

In addition to providing extremely accurate signal analysis, the PSO-200 offers bit error-rate (BER) measurement capabilities that are normally only found in real-time sampling systems. When using any PRBS up to $2^{16}-1$ or user-defined sequence of equivalent length, the PSO-200's powerful algorithms can perform smart analysis of the data recovered to estimate the BER. Additionally, a powerful gearbox, an error summary and a visual representation of all errors in all graphs allow users to identify potential error sources faster.

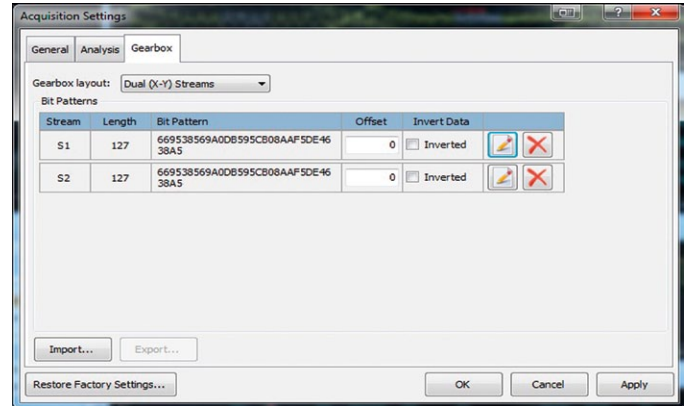
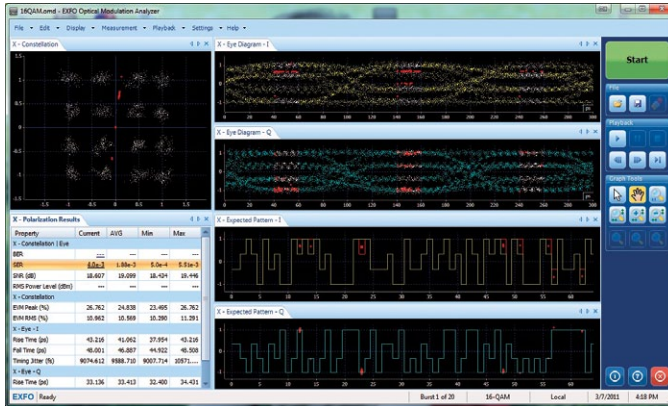

Digital Filtering (optional)

Once the transmitter seems fully optimized, it can be interesting to see the impact of bandwidth-limited network elements, such as the receiver front-end on the signal. This can be simulated by applying a digital filter on the recovered signal. Butterworth, Bessel-Thomson and Chebyshev filters of any bandwidth and order up to eight are available in the PSO-200 and can be applied to the recovered signal.

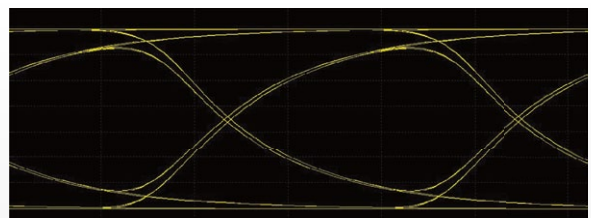
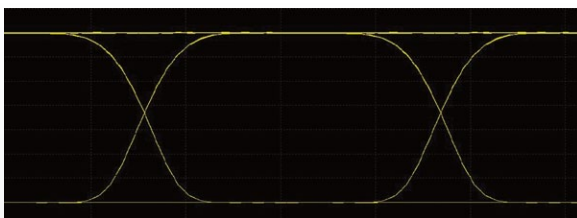
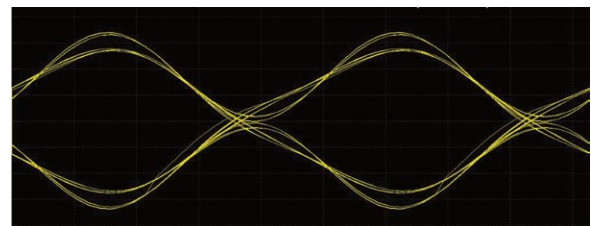
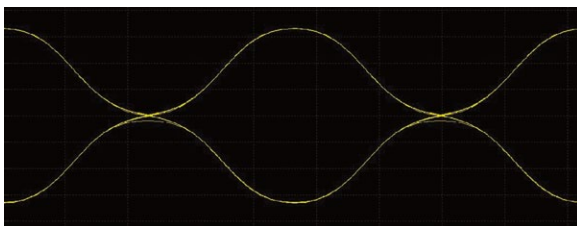

Offline Processing (optional)

Now with the PSO-200, it has never been this easy to re-process the data acquired offline to perform more advanced analysis or validate the transmission parameters or quality, using customer-specific algorithms. With a touch of the Save function, EXCEL- and MatLAB-compatible files, including the raw data acquired, can easily be exported. Acquired traces are also stored in the PSO-200 proprietary format. All the files stored include the acquired traces and online analysis data, and since the PSO-200 software can be installed on any PC; this means that acquired traces and signals can be re-opened offline for further analysis—as if working on the instrument itself.

SPECIFICATIONS ^a
General

Modulation formats supported ^b	OOK, BPSK, PSK, QPSK, DQPSK, 16-QAM ^c , APSK, DP-RZ, DP-NRZ, DP-APSK, DP-BPSK, DP-PSK, DP-QPSK, DP-DQPSK, DP-16-QAM Any PRBS or user-defined pattern
Transmission rates ^d	> 100 GBd ^e
Pattern length supported	2 ¹⁵ -1 in Repetitive Pattern Mode or PRBS. Unlimited (random data) in Constellation or Eye Mode.
Analog bandwidth	≥60 GHz

Optical signal input

Wavelength range	1530 to 1565 nm (191.5 – 196.25 THz)
Sensitivity ^{d,f}	-15 dBm
Saturation power ^{d,g}	16 dBm
Maximum input power (damage)	25 dBm
Jitter ^d	200 fs
Maximum measurable SNR ^{d,f}	25 dB
I-Q imbalance	0.15 dB
X-Y polarization imbalance	0.25 dB
Phase error ^d	1.0 °
Skew accuracy ^d	500 fs
Chromatic dispersion tolerance (with CD unwrapping enabled) ^h	500 ps
Differential Group Delay tolerance ^h	33% of symbol duration
State of polarization tracking speed ⁱ	190 rad/s
Refresh rate ^{d,i}	1 Hz

External local oscillator input ^k

Optical input wavelength range	1530 to 1565 nm (191.5 – 196.25 THz)
External local oscillator input power range	12 to 15 dBm

User interfaces

Display	15.4 in TFT touchscreen
Ports	LAN and USB (3)
Operating system	Windows 7 TM

Note

- a. All specifications are given at 23 ±2 °C.
- b. Based on our simulations, the phase noise tolerance limit is reached for gaussian distributed laser spectrum with linewidth ≥ 1MHz in random mode and ≥ 10MHz with known repetitive sequences.
- c. RZ version not tested.
- d. Typical.
- e. Signal bandwidth < instrument bandwidth, 100 GBd using DP-16QAM (8 bits / symbol) corresponds to 0.8 Tb/s transmission rate.
- f. CW power at 193.1 THz.
- g. CW power, in least favorable polarization state, at 193.1 THz.
- h. With QPSK signal at 10 GBd.
- i. With QPSK signal at 10 GBd, 10 000 samples.
- j. With DP-QPSK signal at 10 GBd, 10 000 samples, 2⁷-1 pattern length.
- k. Single mode PM fiber, polarization aligned to slow axis, slow axis of fiber aligned to connector key.

MEASUREMENT DISPLAY CAPABILITIES AND ANALYSIS TOOLS

> Constellation diagram for X and Y polarizations	> IQ imbalance
> Constellation masks	> IQ offset
> Eye diagram for I and Q tributaries	> Magnitude error
> Eye diagram masks	> Phase error
> Error vector magnitude	> I error
> Error vector magnitude mask	> Q error
> Time-resolved error vector magnitude	> Quadrature error
> Eye magnitude	> Eye contrast ratio
> Eye intensity	> Eye crossing
> Eye phase	> Duty cycle
> Patterns for I and Q	> Duty cycle distortion
> Magnitude pattern	> Eye extinction ratio
> Intensity pattern	> Eye amplitude and height
> Error vector magnitude pattern	> Eye opening factor
> Phase pattern	> Zero and one level
> Expected patterns for I and Q	> Pulse width
> Markers and histograms	> Eye width
> Raw data	> Rise time and fall time
> Offline data re-analysis with PSO software or other packages	> Timing jitter
> Bit error rate analysis	> Digital filtering
> Symbol error rate analysis	> Averaging
> Chromatic dispersion unwrapping	> External trigger for burst acquisitions

GENERAL SPECIFICATIONS

Weight	27 kg (59 lb)
Size (H x W x D)	288 mm x 439 mm x 381 mm (11 ⁹ / ₁₆ in x 18 ¹ / ₁₆ in x 15 in)
Temperature operating	10 °C to 35 °C (50 °F to 95 °F)
Relative humidity	80 % non-condensing
Power consumption	193 W

SAFETY

21 CFR 1040.10 and IEC 60825-1:2007
CLASS 1 LASER PRODUCT

ORDERING INFORMATION

PSO-2XX-XX-XX-XX-XX-XX-XX-XX

Model

10 = Single polarization only OMA
 20 = Single/dual polarizations OMA

Transmission rates

20 = For rates lower than 20 GBd
 100 = For rates higher than 100 GBd

Local Oscillator

00 = Without LO input
 ELO = With external LO input

Connectors

EA-EUI-89 = APC/FC, narrow key
 EI-EUI-89 = UPC/FC, narrow key

Other software options

00 = None
 BER = Bit error-rate analysis with gearbox
 MSK = Compliance masks
 OFF = Offline license and data re-analysis

Chromatic Dispersion

00 = No CD unwrapping
 CD = With CD unwrapping

Digital filtering

00 = No digital filtering
 FIL = With digital software filters

Modulation schemes

00 = Standard schemes: OOK, BPSK, PSK, QPSK, DPSK, DQPSK
 QAM = 16 QAM and APSK support

Example: PSO-210-20-QAM-FIL-EA-EUI-89-BER

EXFO Headquarters > Tel.: +1 418 683-0211 | Toll-free: +1 800 663-3936 (USA and Canada) | Fax: +1 418 683-2170 | info@EXFO.com | www.EXFO.com

EXFO serves over 2000 customers in more than 100 countries. To find your local office contact details, please go to www.EXFO.com/contact.

EXFO is certified ISO 9001 and attests to the quality of these products. EXFO has made every effort to ensure that the information contained in this specification sheet is accurate. However, we accept no responsibility for any errors or omissions, and we reserve the right to modify design, characteristics and products at any time without obligation. Units of measurement in this document conform to SI standards and practices. In addition, all of EXFO's manufactured products are compliant with the European Union's WEEE directive. For more information, please visit www.EXFO.com/recycle. **Contact EXFO for prices and availability or to obtain the phone number of your local EXFO distributor.**

For the most recent version of this spec sheet, please go to the EXFO website at www.EXFO.com/specs.

In case of discrepancy, the Web version takes precedence over any printed literature.