

OPAL-SD – Single-die testing

SEMI-AUTOMATED TEST STATION FOR INTEGRATED PHOTONICS

- Accurate, flexible, cost-effective and easily upgradeable testing of photonic integrated circuit (PIC) singulated die with traceable results.

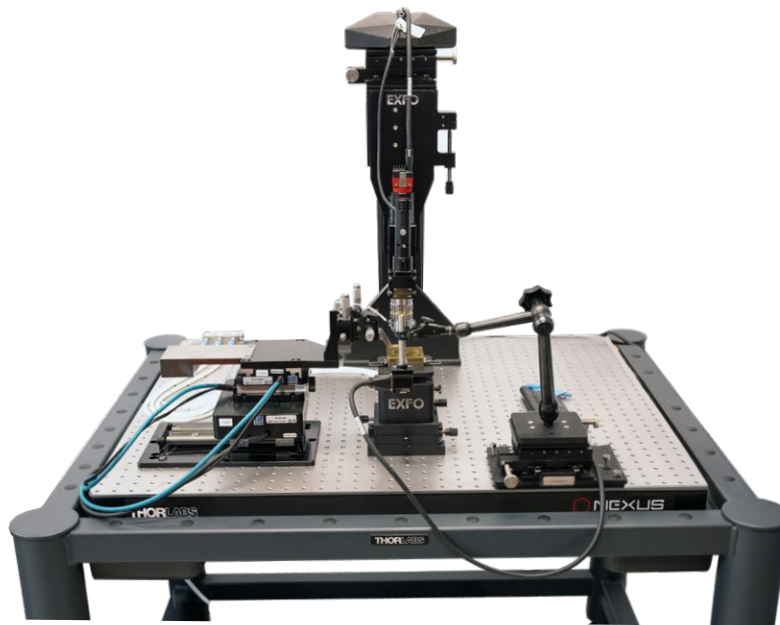

KEY FEATURES

Research-grade solution for semi-automated characterization of a singulated PIC die

Precise and fast optical alignment and electrical probing

Preparation, automated execution (navigation, alignment, instrument control) and data management (repository, analysis) with PILOT software suite (included)

Flexible design with a choice of repositionable optical heads for surface and edge coupling with single fibers or fiber arrays, and electrical probe heads with manual or motorized axis

APPLICATIONS

Optical and electrical probing and testing of PIC at the die, module or bar-level

For R&D, low-volume design verification and test development

Perfect for academia and R&D teams

Platform-agnostic: silicon photonics, indium phosphide, III-V, polymer, heterogeneous

Application-agnostic: telecom & datacom transceivers, quantum, LIDAR, sensors, AI

OPAL SERIES

The OPAL-SD station is part of the OPAL family of test stations dedicated to PIC testing, offering different performance, capability and throughput levels. These test stations are:

- OPAL-SD: a single-die station
- OPAL-MD: a multi-die station
- OPAL-EC: an edge-coupling wafer-level station

All test stations are driven by the EXFO Pilot software. Consequently, the test process and user training developed on one station is completely transferable to another station of the OPAL family. The optical heads, electrical heads, vision systems and IT kits are also transferable from one station to another, lowering the barrier for hardware upgrades.

	OPAL-SD	OPAL-MD	OPAL-EC
DUT	Single die	Single die up to multi dies	Single die up to 12-in wafer
Work area (mm²)	50 × 50	100 × 100	Φ300
Coupling mode	Surface and edge coupling		
Alignment	Manual or automated	Full automated	Full automated
Chuck	Ambient or 0 °C to 150 °C (32 °F to 302 °F) 3 vacuum zones	Ambient or 0 °C to 150 °C (32 °F to 302 °F) 4 vacuum zones	Ambient or 5 °C to 200 °C (41 °F to 392 °F) 4 vacuum zones
Rotation base stage	Manual rotation: 20°	Motorized rotation: 15°	Motorized rotation: 105°
Probe configuration	Optical and electric probes, up to 4		
EXFO Pilot software	Test plan execution, automation, analysis and a license are included with the station		

OPAL-SD PLATFORM

The OPAL-SD single-die test station has been designed as the ideal stepping stone for the high-performance characterization of integrated photonics. The test station offers the speed, accuracy and repeatability needed in the lab environment, while remaining flexible and upgradeable by design.

The EXFO Pilot software suite enhances OPAL-SD hardware capabilities, providing a complete, flexible and scalable software environment for generating test sequences with a visual programming interface, controlling vision, motion systems and test instruments. The complete suite of software applications supports the full test-and-measurements flow turning quality measurements into actionable data, helping users in becoming more data-driven.

The station's hardware consists of a 4-axis manual chuck positioning stage, holding one PIC sample, with thermal control as possible option, mounted on an optical breadboard that can accommodate up to four probe heads for optical or electrical testing. It also includes high-resolution, in-line brightfield top vision system and telecentric side vision systems.

A dedicated license for the EXFO Pilot software suite, installed on an industrial rackmount computer, is included.

EXFO Pilot software for automation and data repository



OPAL station for precise probing

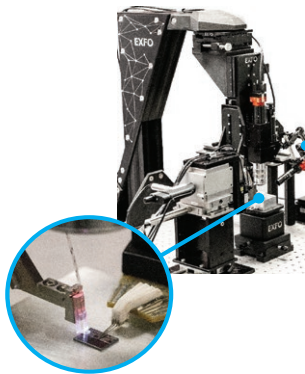

Industry-leading EXFO instruments for full optical characterization







+ Third-party instruments

EXFO's platform for single-die testing includes the OPAL-SD test station, EXFO Pilot software and EXFO T&M instruments for optical characterization of PIC. Third-party instruments can be added and controlled by EXFO Pilot.

OPAL-SD PLATFORM COMPONENTS

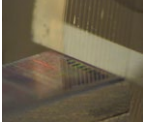
A test station consists of the OPAL-SD main system with two cameras, EXFO Pilot software installed on a PC and a thermal chuck as an option. Probe heads (optical and electrical) should be added for a complete system, depending on the requirements.

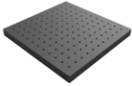
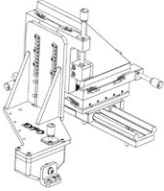
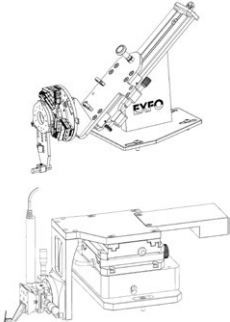
COMPONENTS		DESCRIPTION	OPTION NAMES AND DESCRIPTION
OPAL-SD MAIN STATION	Chuck 	TA: Ambient temperature with vacuum for single-die holder. TCH: Thermally controlled chuck with heating and cooling capabilities.	
	Single-die positioning base stage 	Manual 4-axis high-precision stage.	
	Vision system  	Top high-resolution video-system with 10X magnification using in-line coaxial illumination and 2.9 MP color camera on XYZ manual adjustment. Other magnifications/configuration are available upon request.	
		Magnetic toggleable, side-view 2.9 MP color camera with 3X telecentric magnification on XY manual adjustment and flexible arm.	
	Additional components 	Industrial rackmount PC and accessories. One 27-inch monitor. All drives and cables.	
	PILOT app dedicated license 	Full software suite for complete test and measurement flow of PIC. Automation and control of test station, instruments and data for absolute traceability and reliability of results that are report-ready and AI-ready. One dedicated lifetime license. Additional floating licenses available for multi-user collaboration from anywhere.	
PROBING HEADS ^a	Base 	Honeycomb optical breadboard. BENC: Base frame to isolate base stage from vibration.	
	Electrical heads^b 	PRE-00: 4-axis manual electrical probe positioners. Fine alignment and long travel range. Probe holders compatible with most DC and RF probes. PRE-MO: motorized, XYZ axis electrical probe positioners, resolution of 200 nm.	
	Optical heads^c 	PRO-H: 6-axis motorized piezo-based hexapod (resolution of 1 nm) for precise and fast operation. For edge coupling and surface coupling. Features virtual pivot point capability. Ideal for R&D. Includes mechanical toggle system between engaged/disengaged positions.	
		PRO-S: up to 6-axis motorized DC servo aligner (25-mm XY travel, resolution of 10 nm). Motorized pitch (injection angle) and manual roll and yaw angular adjustment. For surface and edge-coupling. Ideal for production scenario. PRO-ECO: 6 screw-driven aligner (25 mm) and 6-axis motorized. Ideal for surface coupling. Multiple options of fiber holders are available, with various configurations and angles for surface and edge-coupling, from single-fiber to large fiber array unit.	

a. Optical probes (fiber array, fiber) and electrical probes (DC, RF) are not included in the system. If these components are required, please contact an EXFO representative.

b. Includes a probe holder compatible with most DC and RF probes.

c. Includes a probe holder.

SPECIFICATIONS

A standard OPAL-SD test station includes: one OPAL-SD-50 chuck stage motion system, one TA chuck, a top and side vision system, PC with EXFO Pilot software license and accessories.

SINGLE-DIE BASE STAGE, 4-AXIS MANUAL	
X, Y axis travel (mm)	27
Z axis travel (mm)	9
Rz axis travel (degrees)	20
X, Y axis displacement/revolution (mm)	0.3175
Z axis displacement/revolution (mm)	0.085
Rz axis displacement/revolution (degrees)	1.2

CHUCK		
Option name	TA-F3	TH1-G2/F2
Work area (mm ²)	50 × 50	50 × 50
Range ^a	Ambient	0 °C to 150 °C (32 °F to 302 °F)
Resolution	-	0.01 °C (32 °F)
Stability	-	0.05 °C (32 °F)
Heating rate	-	40 °C/min (68 °F/min)
Cooling rate	-	-15 °C/min (14 °F/min)
Vacuum zones ^{b, c}	3 zones	3 zones
Electrical surface ^d	Floating (F)	Grounded (G)/Floating (F)

ORDERING INFORMATION		
OPAL-SD-50-TA-F3	OPAL-SD-50-TH1-G2	OPAL-SD-100-TH1-F2
Floating ambient chuck, 50 mm, coaxial	Thermal chuck 50 mm (0°C-120°C), grounded	Thermal chuck 50 mm (0°C-120°C), floating, coaxial

a. Other temperature ranges available upon request.

b. Custom vacuum patterns available upon request.

c. Generic and custom vacuum adaptor plates available upon request.

d. Other surface electrical options available upon request: floating, triaxial.

OPTICAL HEAD ^a			
Option name	PRO-H	PRO-S	PRO-ECO
Motorized axis	X, Y, Z, Rx, Ry, Rz	X, Y, Z, Rx, Ry, Rz ^b	X, Y, Z, Rx, Ry, Rz
Configuration	Parallel hexapod, piezo ^c	Serial stack, DC servo	Serial stack, screw
X axis travel (mm)	20	25	
Y axis travel (mm)	11	25	
Z axis travel (mm)	20	4.8	12.5
X axis resolution (nm)	1	10	200
Y axis resolution (nm)	1	10	200
Z axis resolution (nm)	1	60	25
X axis repeatability (nm)	Unidirectional: 50	Bidirectional: 70	Bidirectional: 1250
Y axis repeatability (nm)	Unidirectional: 50	Bidirectional: 70	Bidirectional: 1250
Z axis repeatability (nm)	Unidirectional: 50	Bidirectional: 250	Bidirectional: 125
Rx axis travel (°)	23	10	
Ry axis travel (°)	38	10	
Rz axis travel (°)	26	10	
Rx axis resolution (arcsec)	0.04	4	
Ry axis resolution (arcsec)	0.04	4	
Rz axis resolution (arcsec)	0.04	4	
Rx axis repeatability (arcsec)	Unidirectional: 1.5	7	
Ry axis repeatability (arcsec)	Unidirectional: 1.5	7	
Rz axis repeatability (arcsec)	Unidirectional: 1.5	7	
Full virtual pivot point	Yes	No	No
Included ^d		Fiber/array holder	

ORDERING INFORMATION			
	PRO-H-61-20	PRO-S-XX-20	PRO-ECO-60-20
		XX = 30 3 motorized axes (XYZ) and 3 manual axes (Rx, Ry and Rz)	
		XX = 40 4 motorized axes (XYZ and Rx) and 2 manual axes (Ry and Rz)	
		XX = 41 4 motorized axes (XYZ and Ry) and 2 manual axes (Rx and Rz)	
		XX = 42 4 motorized axes (XYZ and Rz) and 2 manual axes (Rx and Ry)	
		XX = 50 5 motorized axes (XYZ and RxRy) and 1 manual axis (Rz)	
		XX = 51 5 motorized axes (XYZ and RxRz) and 1 manual axis (Ry)	
		XX = 52 5 motorized axes (XYZ and RyRz) and 1 manual axis (Rx)	
		XX = 60 6 motorized axes (XYZ & RxRyRz)	

a. Other optical options and configurations are available upon request.

b. Various configurations are available. X, Y, Z are always motorized and angles can be motorized, up to all 6 axes. Specifications here are for all motorized axes, travel may differ for manual version.

c. Piezo equipped with exchangeable drive-units for an easy and fast replacement without the necessity to fully disassemble the positioning system.

d. Multiple options are available for surface and edge coupling configuration, multiple angles available.

ELECTRICAL HEAD

Option name	PRE-00	PRE-MO
Translation stages type	Manual	Motorized X, Y, Z, manual probe angle
X, Y axis travel range (mm)	48	50
Z axis travel range (mm)	48	25
X, Y, Z axis resolution (nm)	–	100
X, Y, Z axis repeatability (µm)	–	1, Bi-directional, typical: 0.3
X, Y, Z axis accuracy (µm)	Typical: 2	5
X, Y, Z axis speed (mm/s)	–	5
X, Y, Z axis displacement/revolution (mm/rev)	0.3	–
Tilt travel	10°	10°
Z coarse step travel (mm)	Min: 6.35 Max: 56	Min: 12.5 Max: 100

ORDERING INFORMATION

PRE-00-20	PRE-MO-20
-----------	-----------

TOP VISION SYSTEM

MECHANICAL BASE HOLDER	
Mounting	Compatible with metric and imperial optical breadboard, at 90° and 45°
X, Y, Z axis travel range (mm)	48
X, Y axis displacement/revolution (mm)	1.41
Z axis displacement/revolution (mm)	0.3175
VISION SYSTEM	
Magnification (X)	10
Numerical aperture	0.28
Depth of field (µm)	3.6
Horizontal field of view (mm)	0.88
Working distance (mm)	34
Resolution (MP)	2.9
Maximum frame rate (fps)	144
Sensor format (inch)	2/3
Sensor type	Color, global shutter, 12 bit
Wavelength	Visible
Illumination type	In-line through video microscope unit, LED illuminator

ORDERING INFORMATION

OPAL-TVVS-00	OPAL-TVSD
Standalone vision system (no mount)	Vision system with single-die mount as well as manual XYZ adjustment

SIDE VISION SYSTEM	
MECHANICAL BASE HOLDER	
Mechanical positioning	6D manual coarse adjustment with articulated arm, XY manual translation stage
Mounting	Compatible with metric and imperial optical breadboard, at 90° and 45°
X, Y axis travel range (mm)	48
X, Y axis displacement/revolution (mm)	1.41
VISION SYSTEM	
Lens type	Telecentric
Magnification ^a (X)	3
Numerical aperture	0.093
Field of view (mm)	2.9 × 2.2
Working distance ^b (mm)	65
Wavelength range	Visible
Resolution (MP)	2.9
Maximum frame rate (fps)	144
Sensor format (inch)	2/3
Sensor type	Color, global shutter, 12 bit
Wavelength	Visible

ORDERING INFORMATION
OPAL-SVS-00

a. Other magnifications options (0.5X, 1X, 2x, 4X, 6X, 8X) available upon request.

b. Other working distances options (40 mm, 110 mm) available upon request.

EXFO PILOT AUTOMATION SOFTWARE

EXFO Pilot is a software platform that orchestrates the complete flow of PIC test and measurement: (i) test preparation, (ii) execution of fully automated navigation, alignment and measurements at a high throughput and (iii) analysis and data management of the results.

Connect & launch



EXFO PILOT app

Prepare

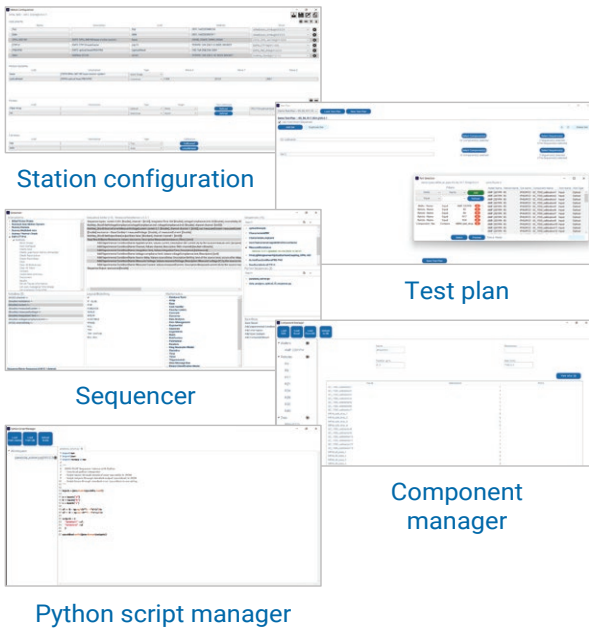

Execute



Analyze

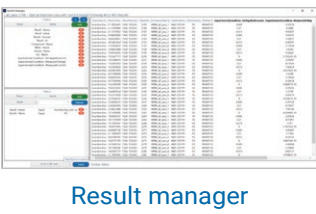

EXFO Pilot App: Prepare – Execute – Analyze with a single software suite.

POWERFUL AND SCALABLE

From application architecture to implementation, the software is designed for scalability in time and volume and helps to implement best practices. It streamlines automation of tasks (preparation, data analysis, reporting) and measurements (navigation, alignment, instrument control) to increase effectiveness. It is composed of multiple applications, each designed for its specific task, with de-coupled concepts and responsibilities.

EXFO Pilot’s “PREPARE” apps help to define which components are being tested, with which instruments, how to test and what to test. Existing Python scripts can also be easily included in the test process. “EXECUTE” apps offer manual and fully automated ways to run the tests and control the connected instruments and station. “ANALYZE” apps allow database queries and fetch information relevant to the particular characterization.

DATABASE BENEFITS

Underlying all applications, the software is linked to a database (cloud-based or on-premises), that acts as a data repository for all of the elements (results and experimental conditions, station configuration, test definition, component definition, drivers, Python scripts). It therefore enables multi-users, multi-site collaboration with a shared common workspace of the data. The database is relational, traceable and scalable to high-volume, making the system natively compatible and designed to support advanced data analysis, artificial intelligence, and business intelligence tools through built-in tools or by interoperability.

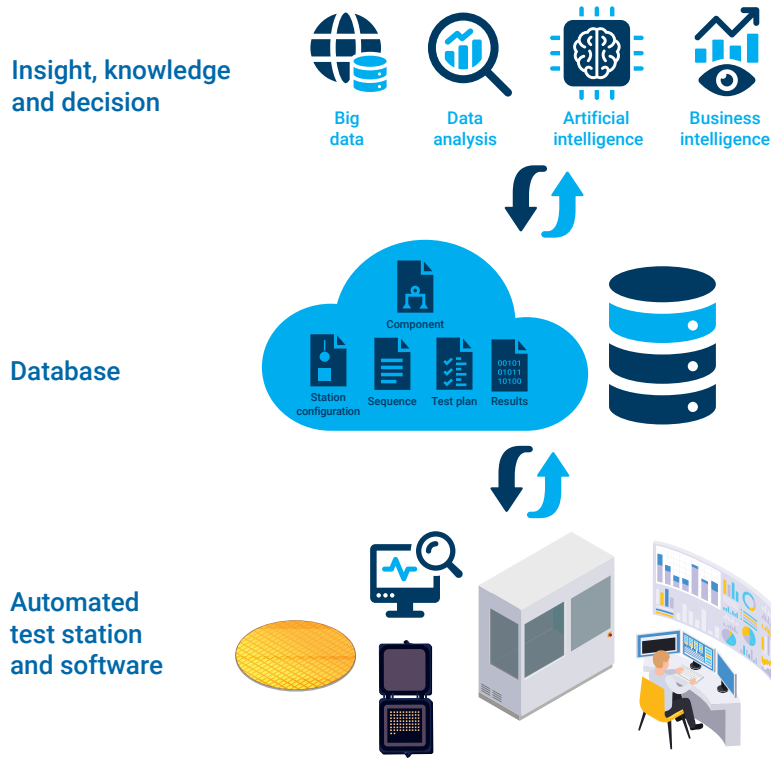

OPAL test stations and PILOT software automates PIC testing with powerful, scalable features, utilizing multiple applications linked to a collaborative database for advanced data analysis and AI.

BUILD YOUR STATION CONFIGURATION

The OPAL-SD platform provides a flexible test environment to build a custom configuration, that can be modified at any time based on your needs and lowers design-for-test (DfT) requirements. Optical and electrical probes can be positioned around the wafer or die under test in any cardinal orientation (East/West/North/South), up to a total of four.

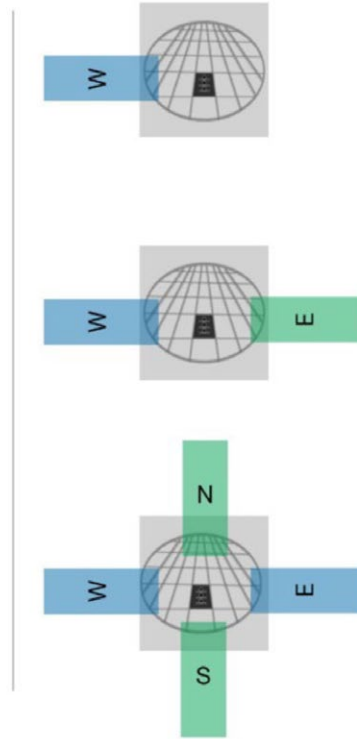
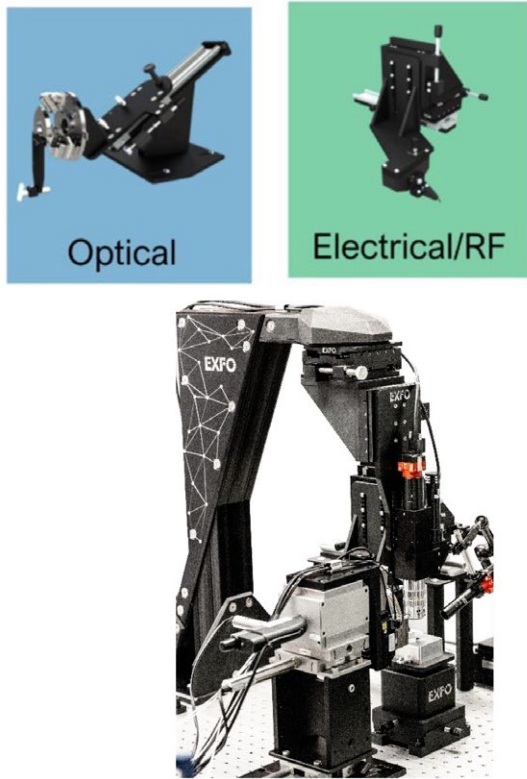

Reconfiguration of OPAL-SD optical and electrical probe heads at any time for fast re-tooling.

GENERAL SPECIFICATIONS – MAIN SYSTEM	
Size (H × W × D)	1438 mm × 914 mm × 945 mm (56 ⁵ / ₈ in × 36 in × 37 ¹ / ₄ in)
Weight (kg) ^a	160 kg (352.7 lb)
Operating environment ^b	Use in a clean environment to avoid temperature variations, vibrations, humidity and dust.
Base	Base frame with passive vibration isolation, canisters and feet. Available as an option.
Maximum number of electrical or optical heads	Up to 4
Optical breadboard	Grid of M6 threaded mounting holes, 25 mm hole spacing, black anodized for reduced reflections
Workstation computer	Intel i5 CPU, 16 GB RAM, 256 GB SSD, 2 Ethernet ports, multiple USB ports, Windows 11 Pro, mouse and keyboard included.
Monitor	27 in
Cables, power supply, drive, controllers	All included
Additional communication ports on base station for equipment	Ethernet Cat 6 RJ54, USB-A 3.0

Note: Use the system in a low-vibration environment. Excessive floor or acoustical vibration can negatively impact system performance. Although the base of the station includes a passive vibration isolation system, the expected vibration level for the operation of the OPAL-SD should be equal to or below the VC-A vibration criteria curve for best performances, especially for edge-coupling alignment. The velocity should be below 50 µm/s, when measured by the one-third octave bands of frequency over 8 to 80 Hz. At this level, vibrations are not perceptible. Else, contact us for more information on an active vibration damping system.

a. The exact mass of the main system depends on the selected configuration.

b. Use the system in a controlled environment. Environmental temperature variations will degrade performance.

TECHNICAL DRAWINGS

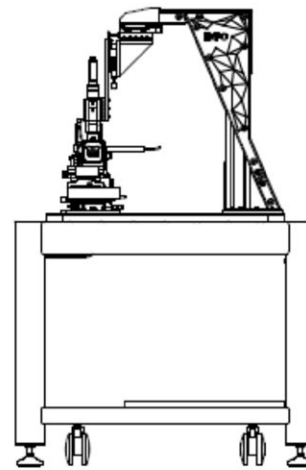
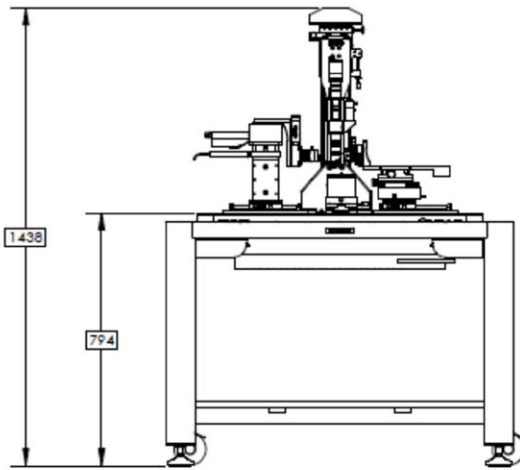
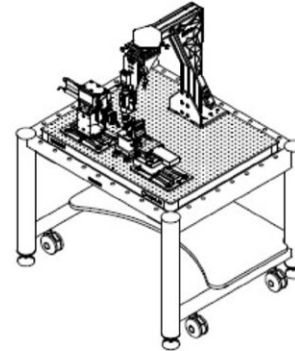
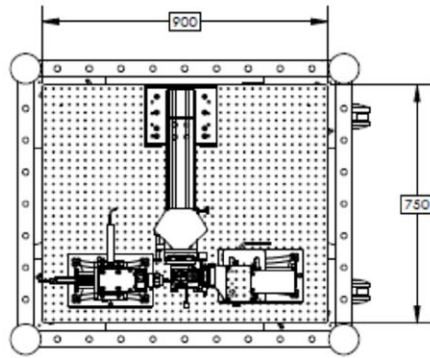

Technical drawing of the OPAL-SD-50 main system with dimensions in millimeters. Shown with one (1x) PRO-S-30 optical head, one (1x) PRO-ECO-60 optical head, and one (1x) base frame. Not shown: included industrial rackmount PC and IT kit (monitor, keyboard, mouse). Also not shown: chiller and thermal chuck controller included with -TH1 option, as well as optical and electrical test equipment. Configuration non-final.

EXFO headquarters T +1 418 683-0211 **Toll-free** +1 800 663-3936 (USA and Canada)

EXFO serves over 2000 customers in more than 100 countries. To find your local office contact details, please go to www.EXFO.com/contact.

For the most recent patent marking information, please visit www.EXFO.com/patent. EXFO is certified ISO 9001 and attests to the quality of these products. EXFO has made every effort to ensure that the information contained in this specification sheet is accurate. However, we accept no responsibility for any errors or omissions, and we reserve the right to modify design, characteristics and products at any time without obligation. Units of measurement in this document conform to SI standards and practices. In addition, all of EXFO's manufactured products are compliant with the European Union's WEEE directive. For more information, please visit www.EXFO.com/recycle. **Contact EXFO for prices and availability or to obtain the phone number of your local EXFO distributor.**

For the most recent version of this spec sheet, please go to www.EXFO.com/specs.

In case of discrepancy, the web version takes precedence over any printed literature.