

OPAL-MD – Multi-die testing

AUTOMATED TEST STATION FOR INTEGRATED PHOTONICS

- Accurate, automated, fast and cost-effective testing of photonic integrated circuits (PIC) with traceable results.

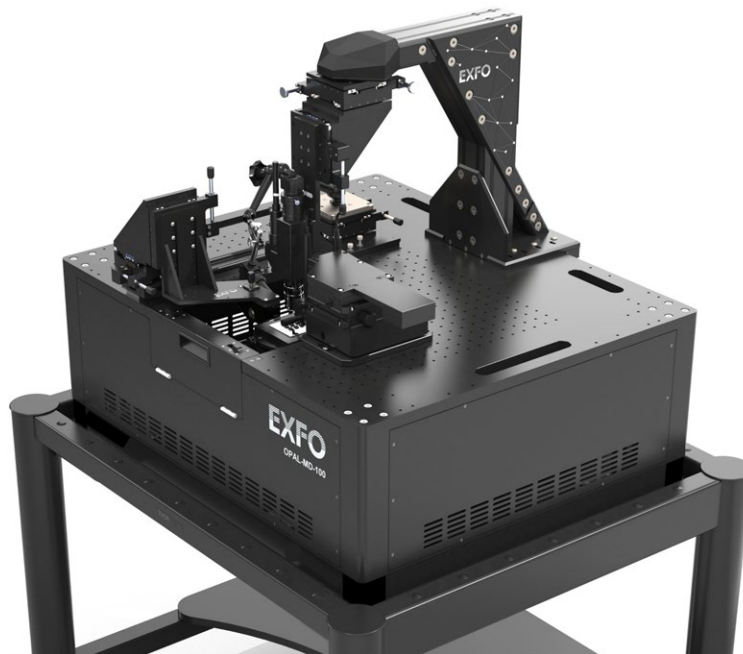

KEY FEATURES

Characterization of multiple singulated dies in one automated execution

Complete PIC testing platform for precise and repeatable optical alignment and electrical probing

Preparation, automated execution (navigation, alignment, instrument control) and data management (repository, analysis) with the included EXFO Pilot software suite

Flexible design with repositionable optical and electrical RF/DC heads

Different probe head options, as needed: Optical head models with up to 6 motorized axes for surface and edge coupling with single fibers or fiber arrays; Electrical heads with manual or motorized axes

APPLICATIONS

From R&D, design verification and process development to pilot production

Automated testing of multiple singulated dies from multi-project wafer run

DUT-agnostic: can test singulated dies (single to tens), reticles, custom cuts, bars, wafers. All samples up to 100×100 mm.

In-depth analysis of statistical circuit performance and yield

Opto-electronic testing on any integrated photonic platform: silicon photonics, indium phosphide, III-V, polymer, heterogeneous

Application-agnostic: telecom and datacom transceivers, quantum, LIDAR, sensors, AI for surface and edge coupling with single fiber or fiber-array to prototyping and pilot production

OPAL SERIES

The OPAL-MD station is part of the OPAL family of test stations dedicated to PIC testing, offering different performance, capability and throughput levels. These test stations are:

- OPAL-SD: a single-die station
- OPAL-MD: a multi-die station
- OPAL-SC: a surface-coupling wafer-level station
- OPAL-EC: an edge-coupling wafer-level station

All test stations are driven by the EXFO Pilot software. Therefore, the test process and user training developed on one station is completely transferable to another station of the OPAL family. The optical heads, electrical heads, vision systems and IT kits are also transferable from one station to another, lowering barriers for hardware upgrades.

	OPAL-SD	OPAL-MD	OPAL-SC	OPAL-EC
DUT	Single die	Single die up to multi dies	Single die up to 8-in wafer	Single die up to 12-in wafer
Work area (mm)	50 × 50	100 × 100	Φ200	Φ300
Coupling mode	Surface and edge coupling	Surface and edge coupling	Surface coupling	Surface and edge coupling
Alignment	Manual or automated	Full automated	Full automated	Full automated
Chuck	Ambient or 0 °C to 120 °C (32 °F to 248 °F) 1 vacuum zone	Ambient or 0 °C to 120 °C (32 °F to 248 °F) 4 vacuum zones	Ambient or 0 °C to 120 °C (32 °F to 248 °F) 4 vacuum zones	Ambient or 0 °C to 200 °C (32 °F to 392 °F) 4 vacuum zones
Rotation base stage	Manual rotation: 20°	Motorized rotation: 15°	Motorized rotation: 15°	Motorized rotation: 105°
Probe configuration	Optical and electric probes Up to 4	Optical and electric probes Up to 3	Optical and electric probes Up to 4	Optical and electric probes Up to 4
EXFO Pilot software	Test plan execution, automation, analysis and a license are included with the station	Test plan execution, automation, analysis and a license are included with the station	Test plan execution, automation, analysis and a license are included with the station	Test plan execution, automation, analysis and a license are included with the station

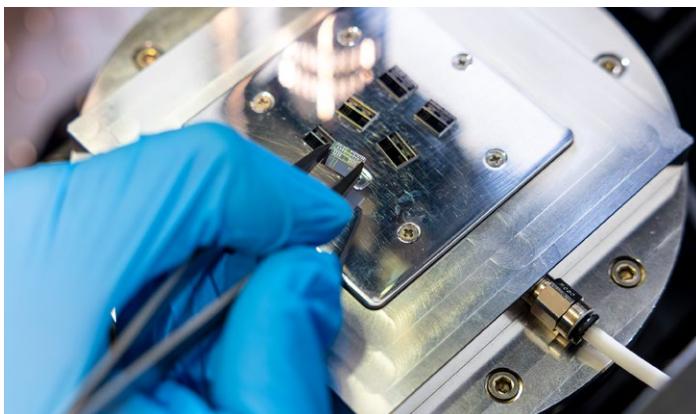

Figure 1. Testing multiple singulated dies at once with motorized base stage and automated navigation.

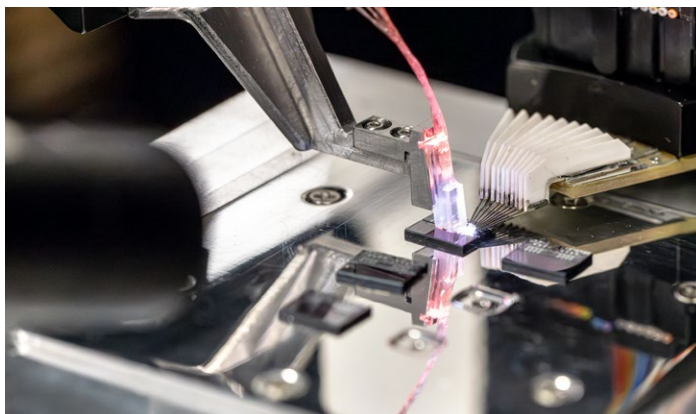

Figure 2. Test setup comprised of EXFO's OPAL-MD, EXFO Pilot software, CTP10, T500S or T200S lasers and a third-party SMU unit, as part of a complete and automated test and data management solution for optical characterization of photonic integrated circuits.

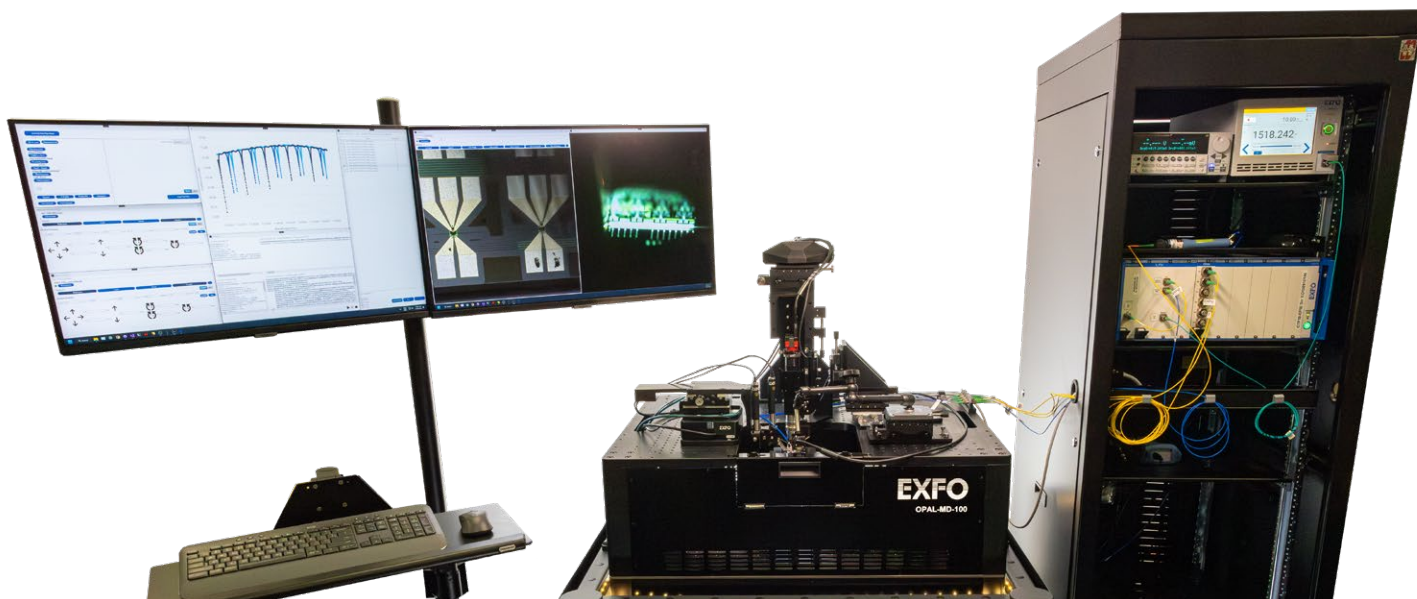

Figure 3. Optical and electrical probing. Shown here with fiber array for surface coupling and DC probe. Probes not included.

OPAL-MD PLATFORM

The OPAL-MD multi-die test station is the keystone of EXFO’s high performance characterization solution for integrated photonics with accurate, repeatable, flexible and fast hardware. The EXFO Pilot software suite enhances the OPAL-MD hardware capabilities to provide an automated testing station and a source of quality measurements that can be turned into actionable data. The complete suite of applications is a platform that supports the full test-and-measurements flow and helps users to become more data-driven. Combined with EXFO’s advanced optical measurement capabilities and open to any third-party instrument, the OPAL-MD is a complete platform for PIC testing.

EXFO Pilot software for automation and data repository



OPAL station for precise probing



Industry-leading EXFO instruments for full optical characterization



+ Third-party instruments

Figure 4. EXFO’s platform for multi-die testing comprising the OPAL-MD test station, EXFO Pilot software and EXFO test and measurement instruments for optical characterization of PIC. Third-party instruments can be added and controlled by EXFO Pilot.

The station’s hardware consists of a motorized 4-axis motion system chuck positioning stage, holding one or multiple samples over an area of 100×100 mm², with thermal control as an option. The station can accommodate up to three probe heads for optical or electrical probes. It also includes a high-resolution, in-line brightfield top vision system and a telecentric side vision system.







The OPAL-MD includes a dedicated license for the EXFO Pilot software suite, installed on an industrial rackmount computer.

The high resolution and repeatability of the base motion system and motorized optical head translates to lower insertion loss and error margin on optical measurements.

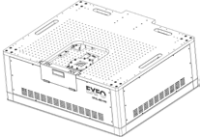
By providing the capability to test multiple dies and circuits efficiently, in a single test execution, the OPAL-MD probe station is effective at building a comprehensive and accurate dataset. It enables the users to get insight from statistical analysis; this data can be used to analyze and extract foundry-specific fabrication variations, system performance and yield. Such information is also valuable to iterate R&D towards high-performance and fabrication-tolerant circuits.

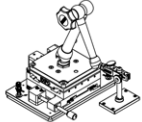
OPAL-MD-100 PLATFORM COMPONENTS

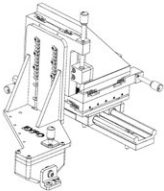
A test station consists of the OPAL-MD main system with EXFO Pilot software, with a thermal chuck as an option. Probing heads (optical and electrical) types and number of units should be added for a complete system, depending on the requirements.

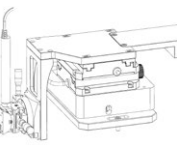
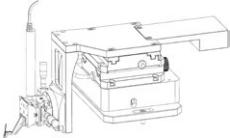
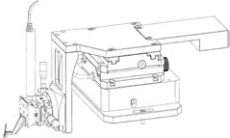
COMPONENTS		DESCRIPTION	OPTION NAMES AND DESCRIPTION
OPAL-MD MAIN SYSTEM	Chuck 	Aluminium surface, ambient temperature, chuck with vacuum multi-die holders. Electrical surface connection options.	TCH ^a : Thermally controlled chuck with heating and cooling capabilities.
	Wafer positioning base stage 	Motorized 4-axis multi-die positioning. Optical breadboard.	
	Vision system  	Top high-resolution video-system with 10X magnification using in-line coaxial illumination and 2.9 MP color camera on XYZ manual adjustment. Magnetic toggleable, side-view 2.9 MP color camera with 3X telecentric magnification on XY manual adjustment and flexible arm.	Other magnifications/configuration are available upon request.
	Additional components 	Industrial rackmount PC and accessories. One 27-inch monitor. All drives and cables.	Top enclosure
	EXFO Pilot app dedicated license 	Full software suite for complete test and measurement flow of PIC. Automation and control of test station, instruments and data for absolute traceability and reliability of results that are report-ready and AI-ready. One dedicated life-time license.	Additional floating licenses available, for multi-user collaboration from anywhere.
PROBING HEADS ^b	Electrical heads^c  	PRE-00 : 4-axis manual electrical probe positioners. Fine alignment and long travel range. Probe holders compatible with most DC and RF probes. PRE-MO : motorized, XYZ axis electrical probe positioners, resolution of 200 nm.	Options of left, right and straight arm configuration.
	Optical heads^d   	PRO-H : 6-axis motorized piezo-based hexapod (resolution of 1 nm) for precise and fast operation. For edge coupling and surface coupling. Features virtual pivot point capability. Ideal for R&D. Includes mechanical toggle system between engaged/disengaged positions. PRO-S : up to 6-axis motorized DC servo aligner (25-mm XY travel, resolution of 10 nm). Motorized pitch (injection angle) and manual roll and yaw angular adjustment. For surface and edge-coupling. Ideal for production scenario. PRO-ECO : 6 screw-driven aligner (25 mm) and 6-axis motorized. Ideal for surface coupling.	<ul style="list-style-type: none"> Options of straight, left and right probe arm Multiple options of fiber holders are available, with various configurations and angles for surface and edge-coupling, from single-fiber to large fiber array unit

a. Operation below 0°C requires top enclosure option to avoid water frost.

b. Optical probes (fiber array, fiber) and electrical probes (DC, RF) are not included in the system. If these components are required, please contact an EXFO representative.

c. Includes a probe holder compatible with most DC and RF probes.

d. Includes a probe holder.

SPECIFICATIONS

A standard OPAL-MD test station includes: one OPAL-MD-100 chuck stage motion system, one TA chuck, a top and side vision system, PC with EXFO Pilot software license and accessories.

CHUCK STAGE MOTION SYSTEM		OPAL-MD-100
MECHANICAL		
X, Y axis	Travel range (mm)	100
	Resolution (μm)	0.15
	Accuracy, typical (μm)	1
	Bidirectional repeatability, typical (μm)	1
	Maximum process speed (mm/s)	20
	Motor type	Recirculating ball bearing, stepper motor
Z axis	Travel range (mm)	4.8
	Resolution (μm)	0.06
	Accuracy, typical (μm)	0.6
	Bidirectional repeatability, typical (μm)	0.1
	Maximum speed (mm/s)	5
	Motor type	Linear ball bearings, DC motor
Rz axis	Travel range	15°
	Resolution	0.9 arcsec; 0.00025°
	Accuracy, typical	36 arcsec; 0.01°
	Bidirectional repeatability, typical	9 arcsec; 0.0025°
	Maximum speed (degree/s)	20
	Motor type	Crossed roller bearings, stepper motor

CHUCK		
Option name	TA-F	TH1-G/F
Work area (mm)	100 × 100, square	100 × 100, square
Range ^a	Ambient	Dew-point (>0 °C) (32 °F) to 120 °C (248 °F)
Resolution	-	0.01 °C (32 °F)
Stability	-	0.05 °C (32 °F)
Heating rate	-	20 °C/min (68 °F/min)
Cooling rate	-	-10 °C/min (14 °F/min)
Vacuum zones ^{b,c}	4 independent zones	4 independent zones
Electrical connection ^d	Floating (F)	Grounded (G)/Floating (F)

ORDERING INFORMATION

OPAL-MD-100-TA-F	OPAL-MD-100-TH1-G	OPAL-MD-100-TH1-F
Floating ambient chuck, 100 mm, coaxial	Thermal chuck 100 mm (0°C-120°C), grounded	Thermal chuck 100 mm (0°C-120°C), floating, coaxial

a. Other temperature ranges available upon request.

b. Custom vacuum patterns and zones available upon request.

c. Generic and custom vacuum adaptor plates available upon request.

d. Other electrical connection options available upon request.

TOP VISION SYSTEM**MECHANICAL BASE HOLDER**

Mounting	Compatible with metric and imperial optical breadboard, at 90° and 45°
X, Y, Z axis travel range (mm)	48
X, Y axis displacement/revolution (mm)	1.41
Z axis displacement/revolution (mm)	0.3175

VISION SYSTEM

Magnification (X)	10
Numerical aperture	0.28
Depth of field (µm)	3.6
Field of view (mm)	2.4
Working distance (mm)	34
Resolution (MP)	2.9
Maximum frame rate (fps)	144
Sensor format (inch)	2/3
Sensor type	Color, global shutter, 12 bit
Wavelength	Visible
Illumination type	In-line through video microscope unit, LED illuminator

ORDERING INFORMATION

OPAL-TVSS-00
Standalone vision system (no mount)

OPAL-TVSW
Vision system with multi-die and wafer mount
as well as manual XYZ adjustment

SIDE VISION SYSTEM**MECHANICAL BASE HOLDER**

Mechanical positioning	6D manual coarse adjustment with articulated arm, XY manual translation stage
Mounting	Compatible with metric and imperial optical breadboard, at 90° and 45°
X, Y axis travel range (mm)	48
X, Y axis displacement/revolution (mm)	1.41

VISION SYSTEM

Lens type	Telecentric
Magnification ^a (X)	3
Numerical aperture	0.093
Field of view (mm)	2.9 × 2.2
Working distance ^b (mm)	65
Wavelength range	Visible
Resolution (MP)	2.9
Maximum frame rate (fps)	144
Sensor format (inch)	2/3
Sensor type	Color, 12 bit, global shutter

ORDERING INFORMATION

OPAL-SVS-00

a. Other magnifications options (0.5X, 1X, 2x, 4X, 6X, 8X) available upon request.

b. Other working distances options (40 mm, 110 mm) available upon request.

OPTICAL HEAD ^a

Option name	PRO-H	PRO-S	PRO-ECO
Motorized axis	X, Y, Z, Rx, Ry, Rz	X, Y, Z, Rx, Ry, Rz ^b	X, Y, Z, Rx, Ry, Rz
Configuration	Parallel hexapod, piezo	Serial stack, DC servo	Serial stack, screw
X axis travel (mm)	20	25	25
Y axis travel (mm)	11	25	25
Z axis travel (mm)	20	4.8	12.5
X axis resolution (nm)	1	10	200
Y axis resolution (nm)	1	10	200
Z axis resolution (nm)	1	60	25
X axis repeatability (nm)	Unidirectional: 50	Bidirectional: 70	Bidirectional: 1250
Y axis repeatability (nm)	Unidirectional: 50	Bidirectional: 70	Bidirectional: 1250
Z axis repeatability (nm)	Unidirectional: 50	Bidirectional: 250	Bidirectional: 125
Rx axis travel (°)	23	10	10
Ry axis travel (°)	38	10	10
Rz axis travel (°)	26	10	10
Rx axis resolution (arcsec)	0.04	4	4
Ry axis resolution (arcsec)	0.04	4	4
Rz axis resolution (arcsec)	0.04	4	4
Rx axis repeatability (arcsec)	Unidirectional: 1.5	7	7
Ry axis repeatability (arcsec)	Unidirectional: 1.5	7	7
Rz axis repeatability (arcsec)	Unidirectional: 1.5	7	7
Full virtual pivot point	Yes	No	No
Orientations	North/East/South/West	North/East/South/West	North/East/South/West
Included ^c	Fiber holder	Fiber holder	Fiber holder

ORDERING INFORMATION

PRO-H-60-yy

xx = 60
6 DoF (piezo-hexapod)

yy = 10
Left arm (counterclockwise)

yy = 20
Straight arm

yy = 30
Right arm (clockwise)

PRO-H61-xx
(with exchangeable motors)

PRO-S-xx-yy

xx = 30
3 motorized axes (XYZ) and
3 manual axes (Rx, Ry and Rz)

xx = 40
4 motorized axes (XYZ and Rx)
and 2 manual axes (Ry and Rz)

xx = 41
4 motorized axes (XYZ and Ry)
and 2 manual axes (Rx and Rz)

xx = 42
4 motorized axes (XYZ and Rz)
and 2 manual axes (Rx and Ry)

xx = 50
5 motorized axes (XYZ and RxRy)
and 1 manual axis (Rz)

xx = 51
5 motorized axes (XYZ and RxRz)
and 1 manual axis (Ry)

xx = 52
5 motorized axes (XYZ and RyRz)
and 1 manual axis (Rx)

xx = 60
6 motorized axes (XYZ & RxRyRz)

yy = 10
Left arm (counterclockwise)

yy = 20
Straight arm

yy = 30
Right arm (clockwise)

PRO-ECO-60-yy

yy = 10
Left arm (counterclockwise)

yy = 20
Straight arm

yy = Right arm (clockwise)

a. Other optical options and configurations are available upon request.

b. Various configurations are available. X, Y, Z are always motorized and angles can be motorized, up to all 6 axes. Specifications here are for all motorized axes, travel may differ for manual version.

c. Multiple options are available for surface and edge coupling configuration, multiple angles available.

ELECTRICAL HEAD

Option name	PRE-00	PRE-M0
Translation stages type	Manual	Motorized X, Y, Z, manual probe angle
X, Y axis travel range (mm)	48	50
Z axis travel range (mm)	48	25
X, Y, Z axis resolution (nm)	-	100
X, Y, Z axis repeatability (µm)	-	1, bidirectional, typical: 0.3
X, Y, Z axis accuracy (µm)	Typical: 2	5
X, Y, Z axis speed (mm/s)	-	5
X, Y, Z axis displacement/revolution (mm/rev)	0.3	-
Tilt travel	10°	10°
Rail system X travel (mm)	180	160
Z coarse step travel (mm)	Min: 6.35 Max: 56	Min: 12.5 Max: 100

ORDERING INFORMATION

	PRE-00-yy	PRE-M0-yy
	yy = 10 Left arm (counterclockwise)	yy = 10 Left arm (counterclockwise)
	yy = 20 Straight arm	yy = 20 Straight arm
	yy = 30 Right arm (clockwise)	yy = 30 Right arm (clockwise)

EXFO PILOT AUTOMATION SOFTWARE

EXFO Pilot is a software platform that orchestrates the complete flow of PIC test and measurement: (i) test preparation, (ii) execution of fully automated navigation, alignment and measurements at a high-throughput and (iii) analysis and data management of the results.

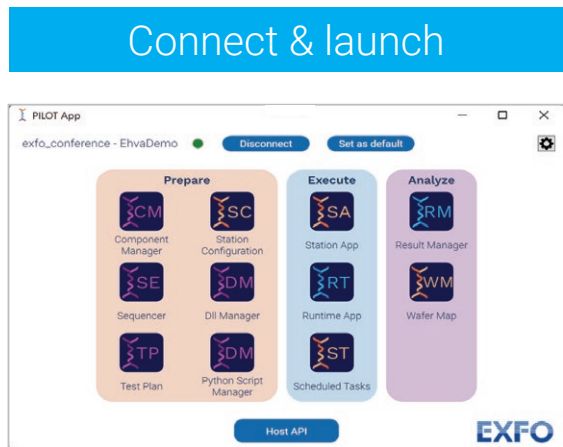

EXFO Pilot app

Prepare

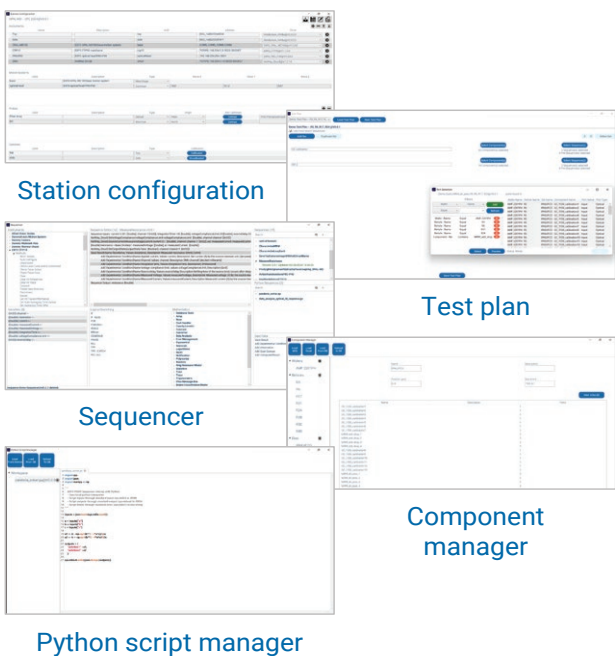

Execute

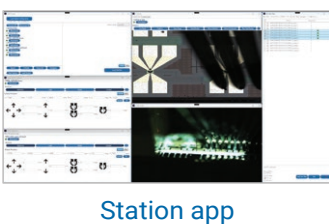

Analyze

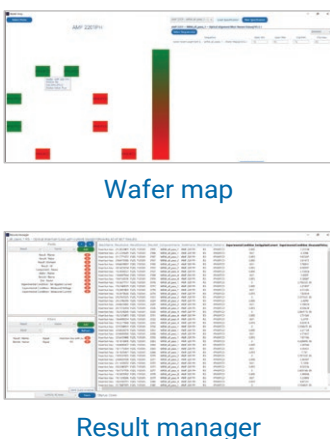

Figure 5. EXFO Pilot app: Prepare – Execute – Analyze with a single software suite.

POWERFUL AND SCALABLE

From application architecture to implementation, the software is designed for scalability in time and volume and helps to implement best practices. It streamlines automation of tasks (preparation, data analysis, reporting) and measurements (navigation, alignment, instrument control) to increase effectiveness. It is composed of multiple applications, each designed for its specific task, with de-coupled concepts and responsibilities.

EXFO Pilot’s PREPARE apps helps define which components are being tested, with which instruments, how to test and what to test. Existing Python scripts can also be easily included in the test process. The EXECUTE app offer manual and fully automated ways to run the tests and control the connected instruments and station. The ANALYZE apps allow database queries and fetch information relevant to particular characterization.



DATABASE BENEFITS

Underlying all applications, the software is linked to a database (cloud-based or on-premises), that acts as a data repository for all of the elements (results and experimental conditions, station configuration, test definition, component definition, drivers, Python scripts). It therefore enables multi-users, multi-site collaboration with a shared common workspace of the data. The database is relational, traceable and scalable to high-volume, making the system natively compatible and designed to support advanced data analysis, artificial intelligence, and business intelligence tools through built-in tools or by interoperability.



Figure 6. OPAL test stations and EXFO Pilot software automates PIC testing with powerful, scalable features, utilizing multiple applications linked to a collaborative database for advanced data analysis and AI.

BUILD YOUR STATION CONFIGURATION

The OPAL-MD platform provides a flexible test environment to build a custom configuration, that can be modified at any time as needed, lowering design-for-test (DfT) requirements. Optical and electrical heads can be positioned around the wafer or die under test up to a total of three orientations used simultaneously.

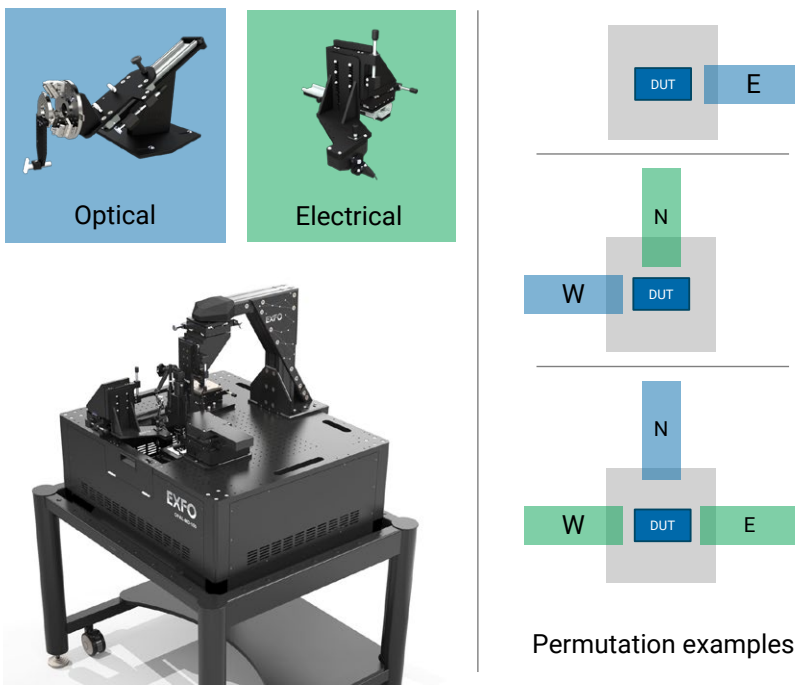

Figure 7. Reconfiguration of OPAL-MD optical and electrical probe heads at any time for fast re-tooling.

GENERAL SPECIFICATIONS – MAIN SYSTEM

Size (H × W × D)	1500 mm × 1095 mm × 945 mm (59 in × 43 1/8 in × 37 1/4 in)
Weight (kg) ^a	350 kg (771.6 lb)
Operating environment ^b	Use in a clean environment to avoid temperature variations, vibrations, humidity and dust
Base	Base frame with passive vibration isolation, canisters and feet
Maximum number of electrical or optical heads	Up to 4
Optical breadboard	Grid of M6 threaded mounting holes, 25 mm hole spacing, black anodized for reduced reflections
Workstation computer	4U rackmount industrial, Intel i7 CPU, 64 GB RAM DDR5, 1 TB SSD, Nvidia RTX 4060 GPU, 3 Ethernet ports (10 + 2.5 + 1 Gbit/s), multiple USB ports, additional PCIe slots, Windows 11 Pro, mouse and keyboard included
Monitor	1 × 27-inch
Cables, power supply, drive, controllers	All included
Additional communication ports on base station for equipment	Ethernet Cat 6 RJ54, USB-A 3.0

Note: Use the system in a low-vibration environment. Excessive floor or acoustical vibration can negatively impact system performance. Although the base of the station includes a passive vibration isolation system, the expected vibration level for the operation of the OPAL-MD-100 should be equal to or below the VC-A vibration criteria curve for best performances, especially for edge-coupling alignment. The velocity should be below 50 µm/s, when measured by the one-third octave bands of frequency over 8 to 80 Hz. At this level, vibrations are not perceptible. Else, contact us for more information on an active vibration damping system.

a. The exact mass of the main system depends on the selected configuration.

b. Use the system in a controlled environment. Environmental temperature variations will degrade performance.

TECHNICAL DRAWINGS

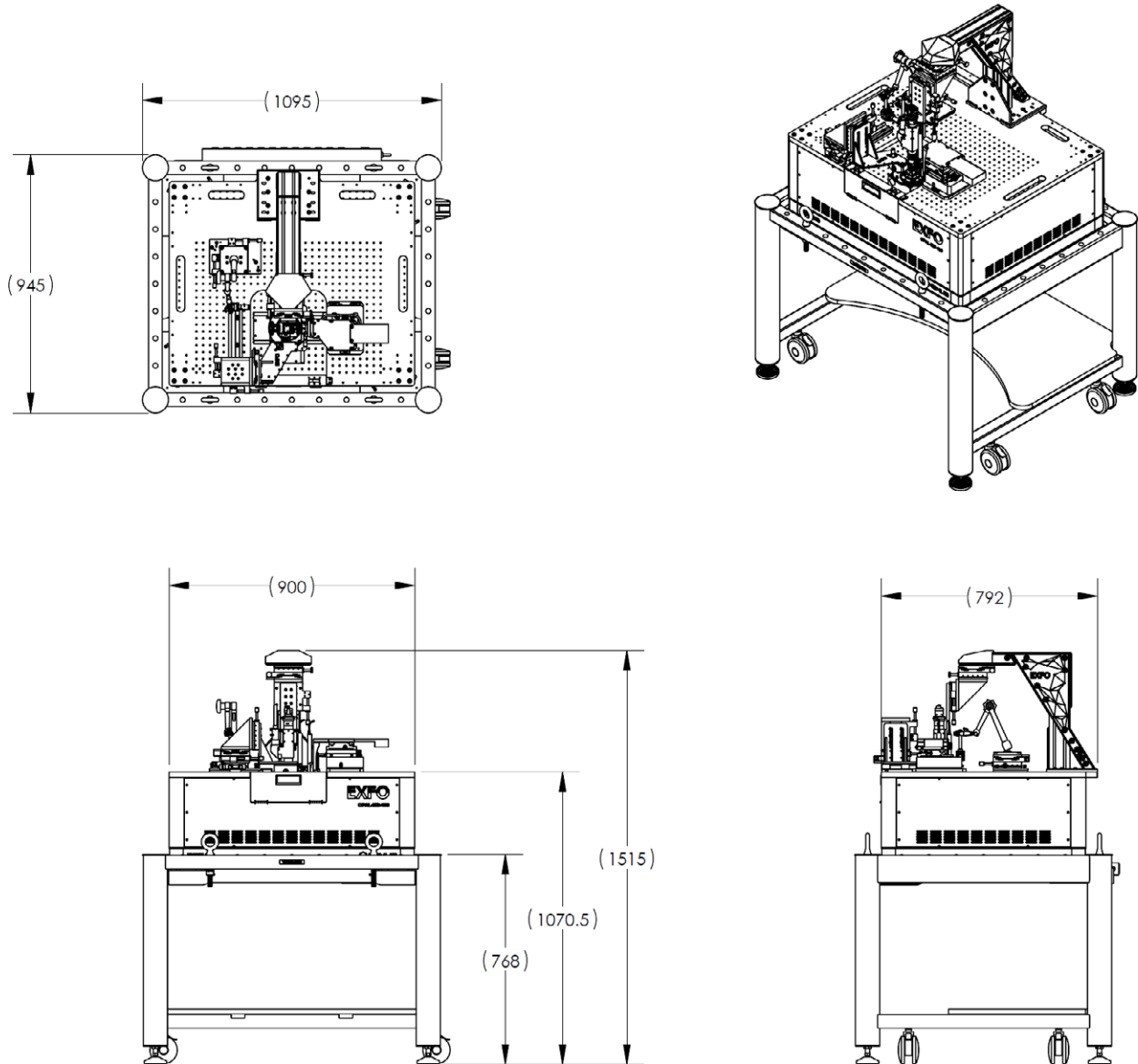

Figure 8. Technical drawing of the OPAL-MD-100 main system with dimensions in millimeters. Shown with one (1x) PRO-S-40 optical head, one (1x) PRE-00 manual electrical head, and one (1x) base frame. Not shown: included industrial rackmount PC and IT kit (monitor, keyboard, mouse). Also not shown: chiller and thermal chuck controller included with -TH1 option, as well as optical and electrical test equipment. Configuration non-final.

EXFO headquarters T +1 418 683-0211 **Toll-free** +1 800 663-3936 (USA and Canada)

EXFO serves over 2000 customers in more than 100 countries. To find your local office contact details, please go to www.EXFO.com/contact.

For the most recent patent marking information, please visit www.EXFO.com/patent. EXFO is certified ISO 9001 and attests to the quality of these products. EXFO has made every effort to ensure that the information contained in this specification sheet is accurate. However, we accept no responsibility for any errors or omissions, and we reserve the right to modify design, characteristics and products at any time without obligation. Units of measurement in this document conform to SI standards and practices. In addition, all of EXFO's manufactured products are compliant with the European Union's WEEE directive. For more information, please visit www.EXFO.com/recycle. **Contact EXFO for prices and availability or to obtain the phone number of your local EXFO distributor.**

For the most recent version of this spec sheet, please go to www.EXFO.com/specs.

In case of discrepancy, the web version takes precedence over any printed literature.